





Parte externa termostático ducha emp. 2 salidas NUANCE X32_X1018100

MODELO **X1018100**

Parte externa termostático ducha emp.2 salidas,con deviasstop 2 salidas,sin parte empotrada,para art.ZA018101,Inox AISI 316L

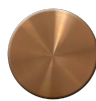
ACABADOS DISPONIBLES

-  **5H** 5H Dark Brass Brushed
-  **5L** 5L Brushed Black Titanium
-  **5N** 5N Oro Rosa Cepillado
-  **D1** D1 Inox Cepillado

CARACTERÍSTICAS

Instalación **Empotrado**
Empotrado 1 **ZA018101**

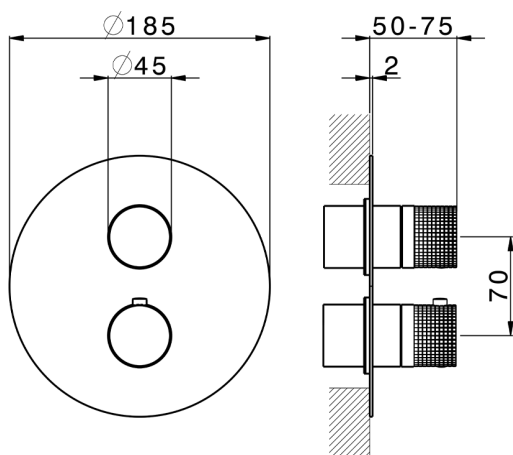
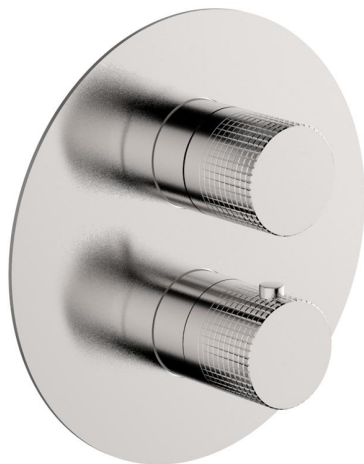

Termostático

El termostático Cisal es tu gestor personal del agua, ayudándote a manejar, controlar y ahorrar agua y energía.



Parte externa termostático ducha emp. 2 salidas NUANCE X32_X1018100

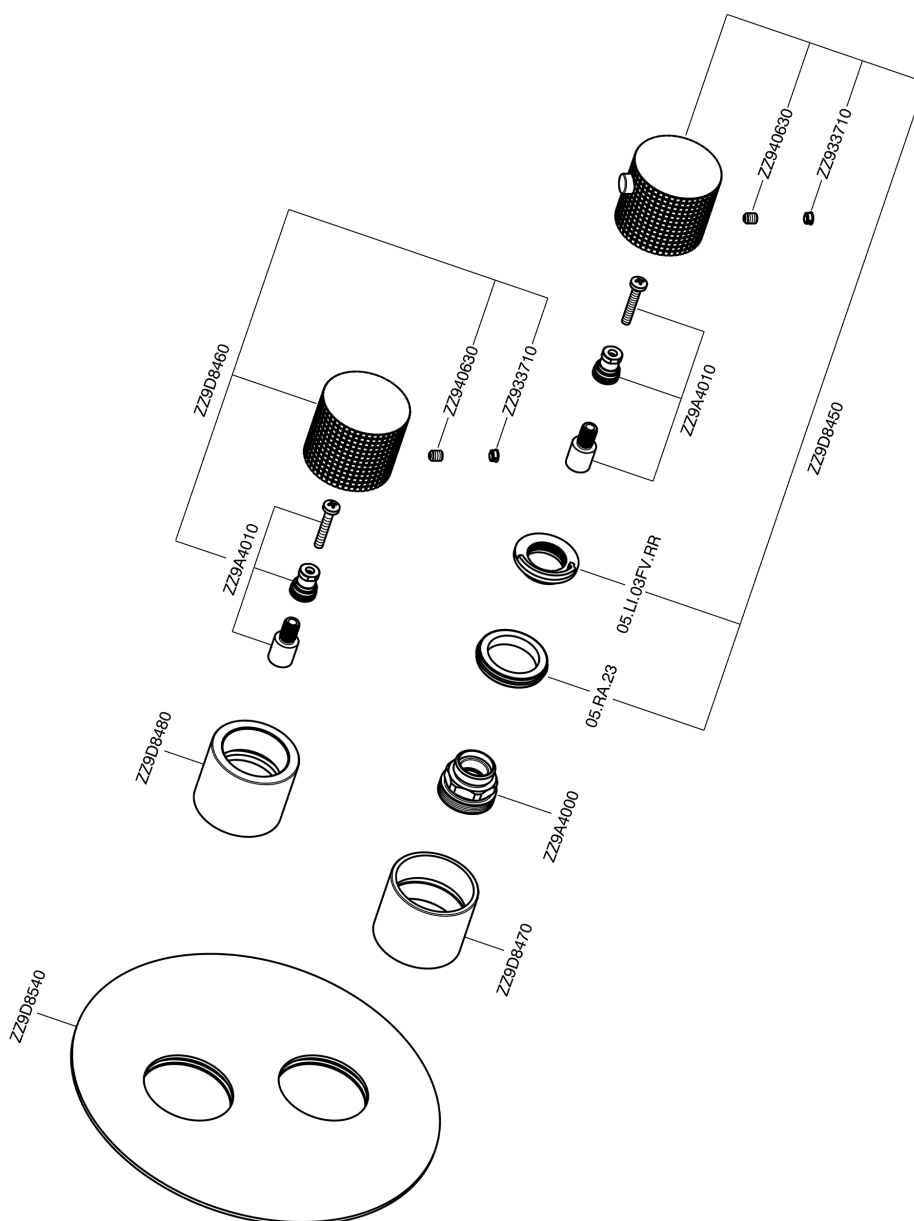

X1018100

<https://es.cisal.it/parte-externa-termostatico-ducha-emp-2-salidas-nuance-x32x1018100>

Parte empotrada termostático ducha 2 salidas EMPOTRADO_ZA018101

MODELO **ZA018101**

Parte empotrada termostático ducha 2 salidas, con devia stop 2 salidas 1/2", sin parte externa



ACABADOS DISPONIBLES



04 04 Sin acabado

CARACTERÍSTICAS

Recambio Cartucho **24.04A.PP**

Empotrado **1**

Cartucho Termostático Plus P 8X20

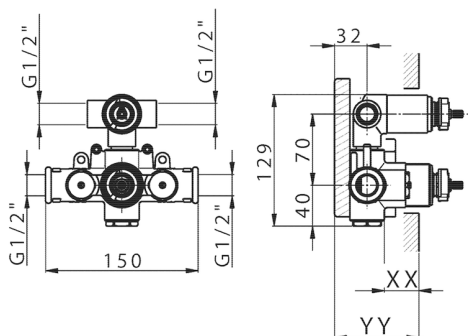

Piastra/Plate/Plaque/Platte/Placa

2-3mm: XX 25-40 YY 76-91

10 mm: XX 16-31 YY 65-80



DeviaStop

La tecnología Cisal DeviaStop le permite ajustar el caudal de agua y dirigirla hacia la salida elegida (rociador superior, ducha de mano, etc.).



Termostático

El termostático Cisal es tu gestor personal del agua, ayudándote a manejar, controlar y ahorrar agua y energía.



2024-09-16