

Parte empotrada termostático 2 funciones PUSH&SHOWER_ZA0G62R0

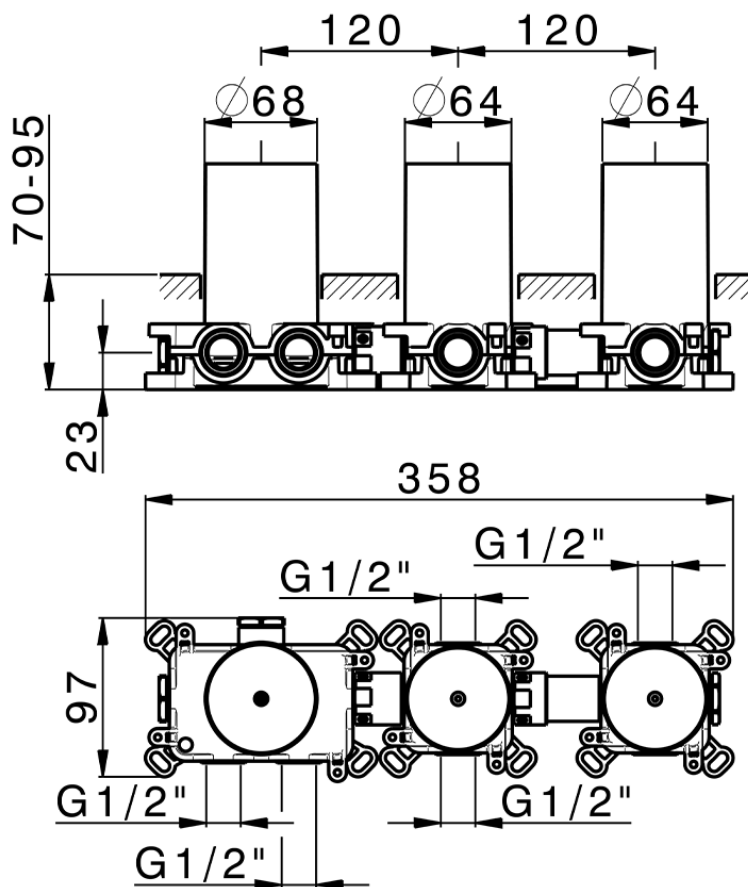

ZA0G62R0

<https://es.cisal.it/parte-empotrada-termostatico-2-funciones-pushshower-za0g62r0>

2026-05-01