

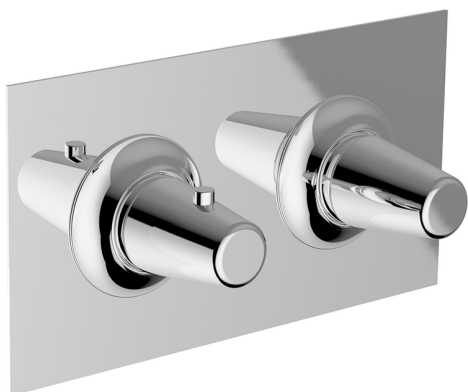



Parte externa termostático ducha emp. 2 salidas VITA_VI019140



MODELO **VI019140**

Parte externa termostático ducha emp.2 salidas,con deviasstop 2 salidas,sin parte empotrada,para art.ZA019140

ACABADOS DISPONIBLES

-  **21** 21 Cromo
-  **2Q** 2Q Black Titanium
-  **40** 40 Negro Mate
-  **4Q** 4Q Blanco Mate

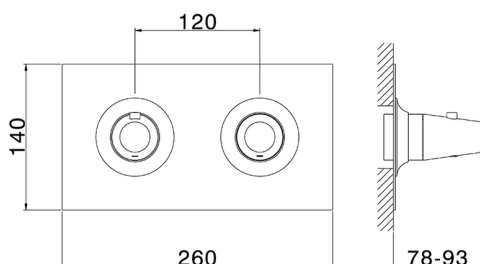

CARACTERÍSTICAS

Instalación **Empotrado**
Empotrado 1 **ZA019140**



Termostático

El termostático Cisal es tu gestor personal del agua, ayudándote a manejar, controlar y ahorrar agua y energía.



Parte externa termostático ducha emp. 2 salidas VITA_VI019140

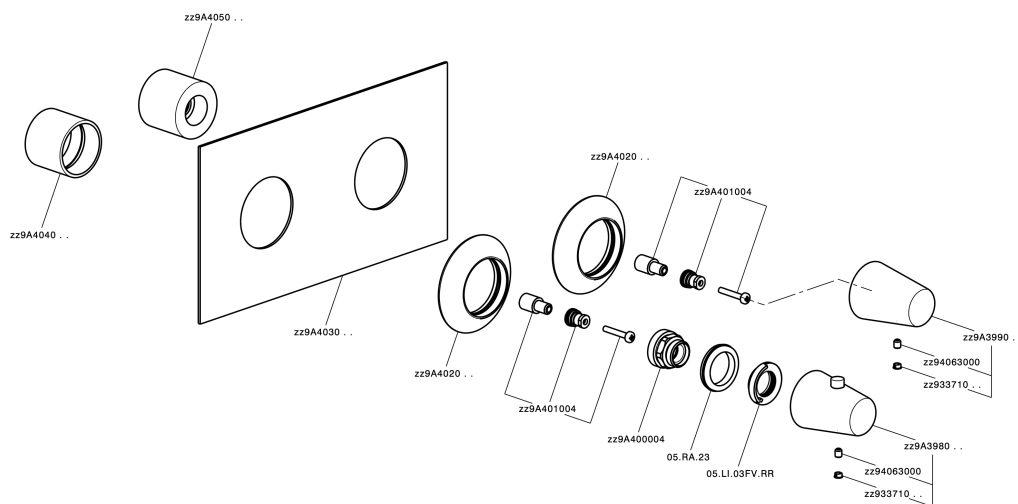

VI019140

<https://es.cisal.it/parte-externa-termostatico-ducha-emp-2-salidas-vita-vi019140>

Parte empotrada termostático ducha 2 salidas EMPOTRADO_ZA019140

MODELO **ZA019140**

Parte empotrada termostático ducha 2 salidas, sin parte externa

ACABADOS DISPONIBLES



CARACTERÍSTICAS

Recambio Cartucho **24.04A.PP**

Empotrado **1**

Cartucho Termostático Plus P 8X20

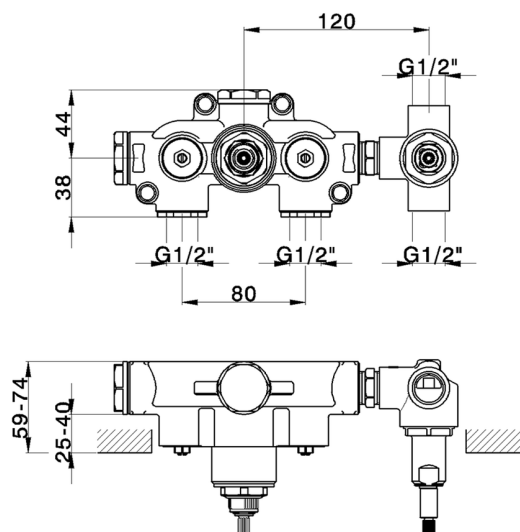

Termostático

El termostático Cisal es tu gestor personal del agua, ayudándote a manejar, controlar y ahorrar agua y energía.



2026-06-19