

Parte externa monomando baño/ducha empotrado ARCANA EMPRESS_EM002100

MODELO **EM002100**

Parte externa monomando baño/ducha empotrado,desviador automático 2 salidas,sin parte empotrada,para art.ZA002210



ACABADOS DISPONIBLES

-  **21** 21 Cromo
-  **24** 24 Oro
-  **26** 26 Cobre Viejo
-  **27** 27 Bronce Viejo
-  **2A** 2A Niquel Satinado Cepillado
-  **74** 74 Cromo/Oro

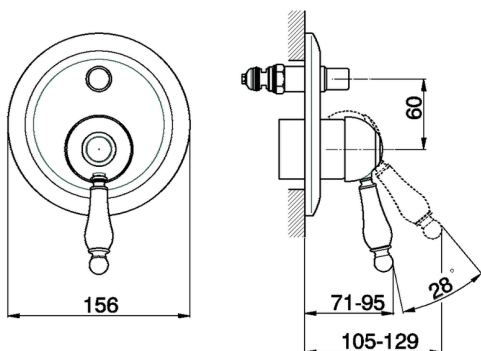

CARACTERÍSTICAS

Instalación	Empotrado
Empotrado 1	ZA002210



Parte externa monomando baño/ducha empotrado ARCANA EMPRESS_EM002100

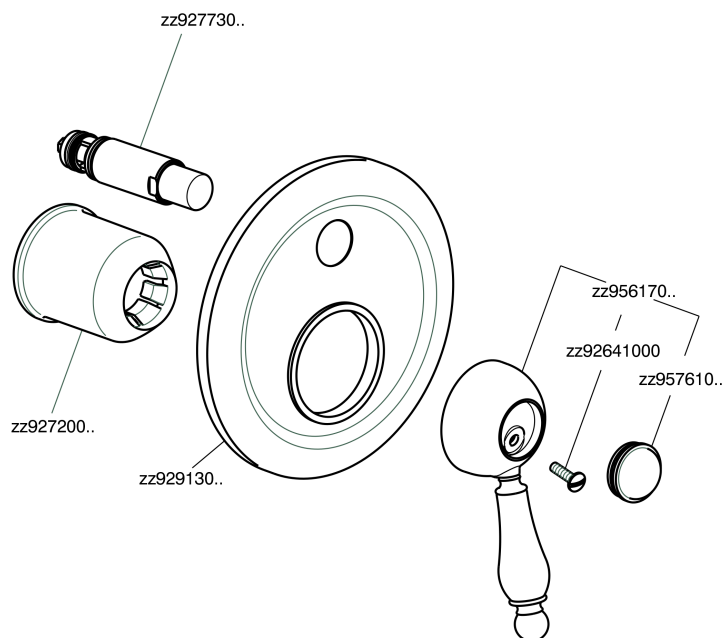

EM002100

<https://es.cisal.it/parte-externa-monomando-bano-ducha-empotrado-arcana-empress-em002100>

Parte empotrada monomando baño/ducha EMPOTRADO_ZA002210

MODELO **ZA002210**

Parte empotrada monomando baño/ducha, desviador
2 salidas 1/2" y 3/4", sin parte externa

ACABADOS DISPONIBLES



04 04 Sin acabado



CARACTERÍSTICAS

Recambio Cartucho **ZZ92909000**

Empotrado **1**

Cartucho Monomando 43 mm

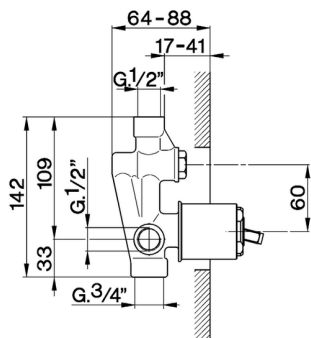

2025-01-15