

## Grifo de un sólo agua TR\_TR000910

**cisal**

### TR 00091

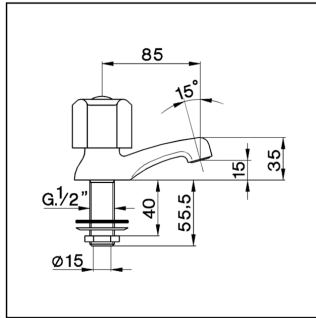

- Rubinetto collo cigno
- Basin pillar tap
- Standventil
- Robinet de lavabo

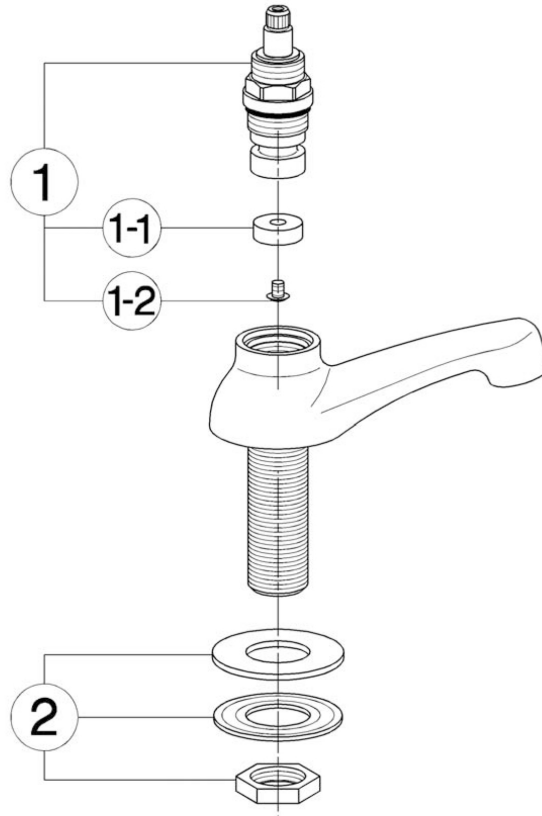

bar	PORTATA BOCCA DI EROGAZIONE * SPOUT FLOW RATE DURCHFLOSS WANNENEINLAUF DEBIT BEC DÉVERSEUR l/min.
0.1	9.5
0.2	13
0.3	17
0.4	19.5
0.5	21.5
1	32

\* con rompigetto  
with antispash  
mit Strahlregler  
avec brise-jet

NR.	DESCRIZIONE DESCRIPTION BESCHREIBUNG DESCRIPTION	N. CODICE CODE NO. WERKSNR. NR. CODE	NR.	DESCRIZIONE DESCRIPTION BESCHREIBUNG DESCRIPTION	N. CODICE CODE NO. WERKSNR. NR. CODE	NR.	DESCRIZIONE DESCRIPTION BESCHREIBUNG DESCRIPTION	N. CODICE CODE NO. WERKSNR. NR. CODE
1	Vitone 1/2" "TR" Headvalve 1/2" "TR" Oberteil 1/2" "TR" Tête 1/2" "TR"	ZZ 92869 0						
1-1	Guarnizione NBR 90 SH. 16,9x5,5x5 Gasket NBR 90 SH. 16,9x5,5x5 Dichtung NBR 90 SH. 16,9x5,5x5 Joint NBR 90 SH. 16,9x5,5x5	ZZ 92699 0						
1-2	Vite M.4x4,5 Screw M.4x4,5 Schraube M.4x4,5 Vis M.4x4,5	ZZ 92625 0						
2	Set installazione rubinetto a colonna Installation set deck-mounted tap Befestigungsset Set installation	ZZ 92740 0						

TR000910

<https://es.cisal.it/grifo-de-un-solo-agua-tr-tr000910>

2026-06-15