





Parte externa monomando baño/ducha empotrado SMOOTH X32_X3002300

MODELO **X3002300**

Parte externa monomando baño/ducha empotrado, Desviador giratorio 2 salidas, sin parte empotrada, para art. Easy-Box ZA000230, con maneta lisa - Inox AISI 316L

ACABADOS DISPONIBLES

-  **5H** 5H Dark Brass Brushed
-  **5L** 5L Brushed Black Titanium
-  **5N** 5N Oro Rosa Cepillado
-  **D1** D1 Inox Cepillado

CARACTERÍSTICAS

Instalación	Empotrado
Empotrado 1	ZA000230

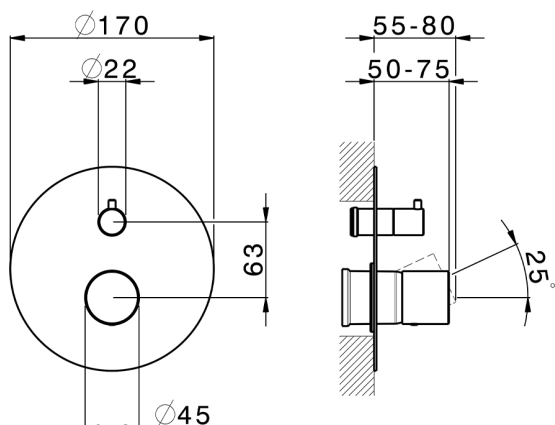
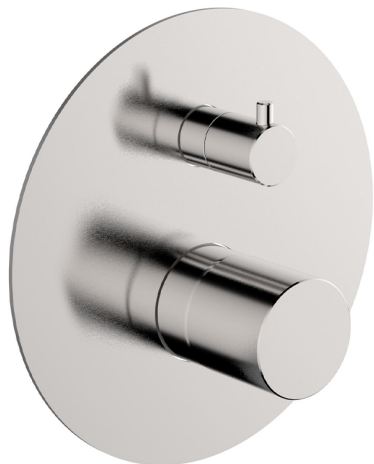

Parte externa monomando baño/ducha empotrado SMOOTH X32_X3002300

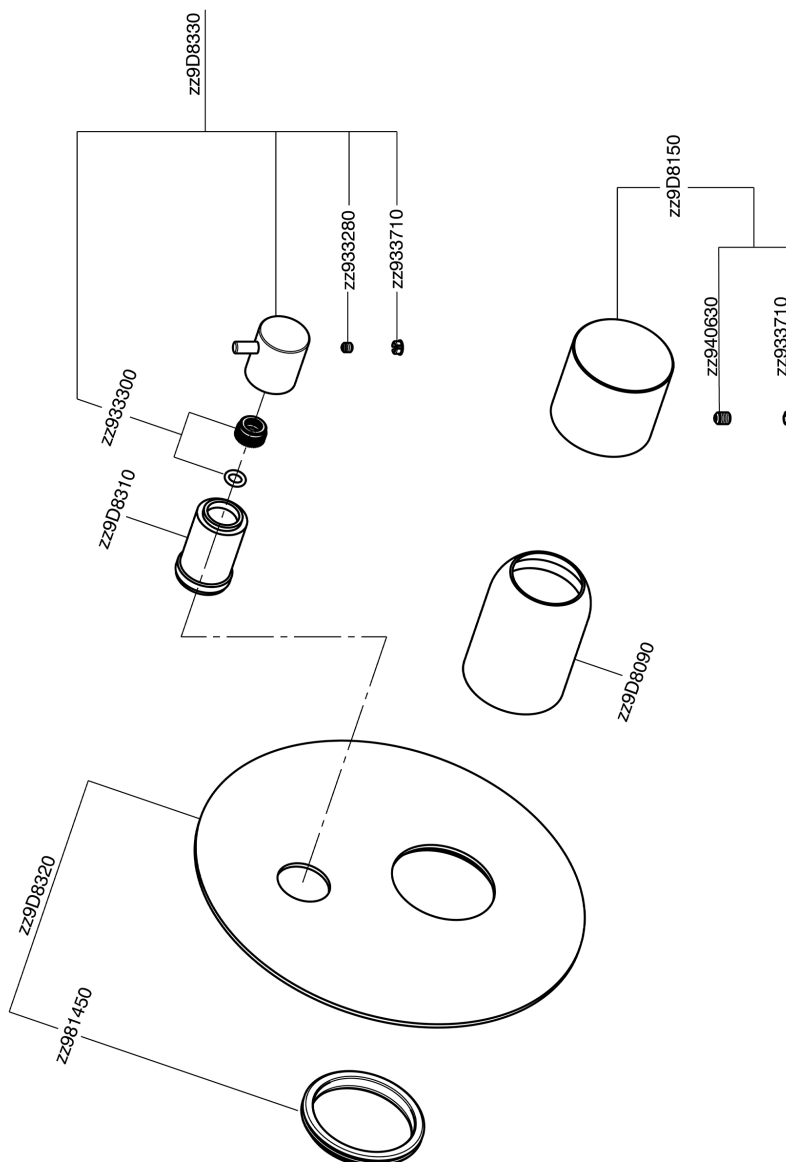

X3002300

<https://es.cisal.it/parte-externa-monomando-bano-ducha-empotrado-smooth-x32x3002300>

2024-09-19