





## Parte externa termostático ducha 3 funciones WELLNESS\_CU01R300



MODELO **CU01R300**

Parte externa termostático ducha 3 funciones, para art.ZA01R300

### ACABADOS DISPONIBLES

-  **21** 21 Cromo
-  **2B** 2B Niquel Brillo
-  **2F** 2F Niquel Cepillado
-  **40** 40 Negro Mate

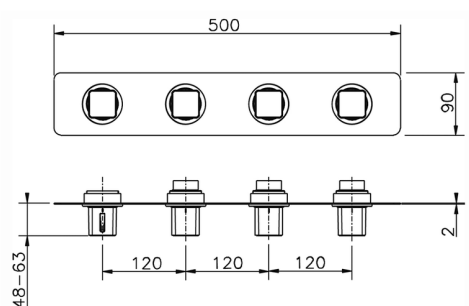

### CARACTERÍSTICAS

Instalación **Empotrado**  
Empotrado 1 **ZA01R300**



### Termostático

El termostático Cisal es tu gestor personal del agua, ayudándote a manejar, controlar y ahorrar agua y energía.



## Parte empotrada termostático 3 funciones EMPOTRADO\_ZA01R300

MODELO **ZA01R300**

Parte empotrada termostático 3 funciones

ACABADOS DISPONIBLES

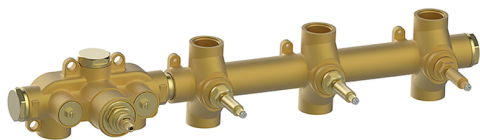

CARACTERÍSTICAS

Recambio Cartucho **23.51A.HF**

Empotrado **1**

**Cartucho Termostático HF**

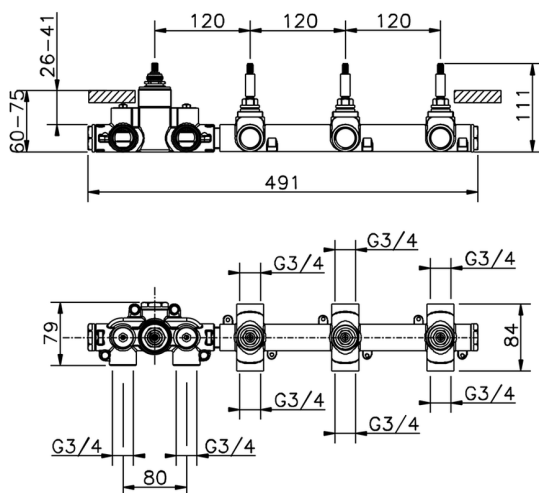

### Termostático

El termostático Cisal es tu gestor personal del agua, ayudándote a manejar, controlar y ahorrar agua y energía.



2024-12-04