

Parte externa monomando lavabo de pared TENDER_C2005512

MODELO **C2005512**

Parte externa monomando lavabo de pared, sin parte empotrada, caño L.250 mm, para art. Easy-Box ZA002450-ZA025510

ACABADOS DISPONIBLES



CARACTERÍSTICAS

Instalación **Empotrado**

Empotrado 1 **ZA002450**

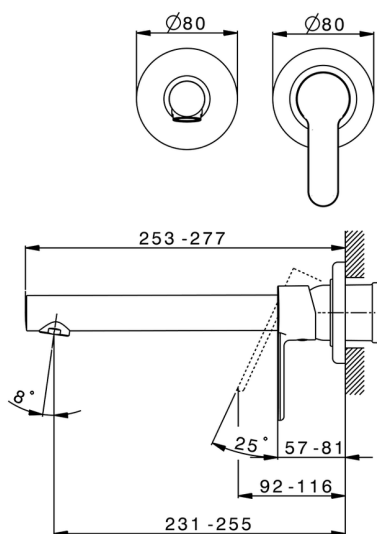

Parte externa monomando lavabo de pared TENDER_C2005512

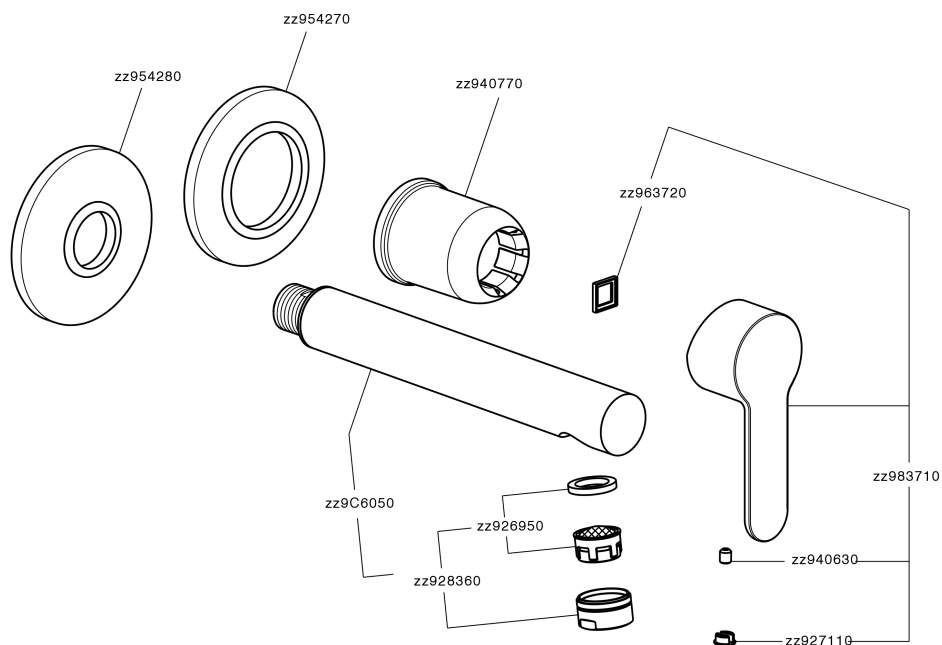

C2005512

<https://es.cisal.it/parte-externa-monomando-lavabo-de-pared-tender-c2005512>

2024-12-22