







## Ducha ARCANA TOSCANA\_TS000441

MODELO **TS000441**

Ducha,sin conjunto ducha,conexión para flexible 1/2"M



ACABADOS DISPONIBLES

-  **21** 21 Cromo
-  **24** 24 Oro
-  **26** 26 Cobre Viejo
-  **27** 27 Bronce Viejo
-  **2A** 2A Niquel Satinado Cepillado
-  **74** 74 Cromo/Oro

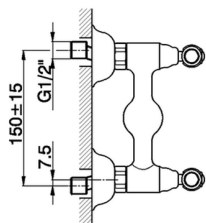
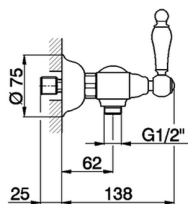

CARACTERÍSTICAS



## Ducha ARCANA TOSCANA\_TS000441

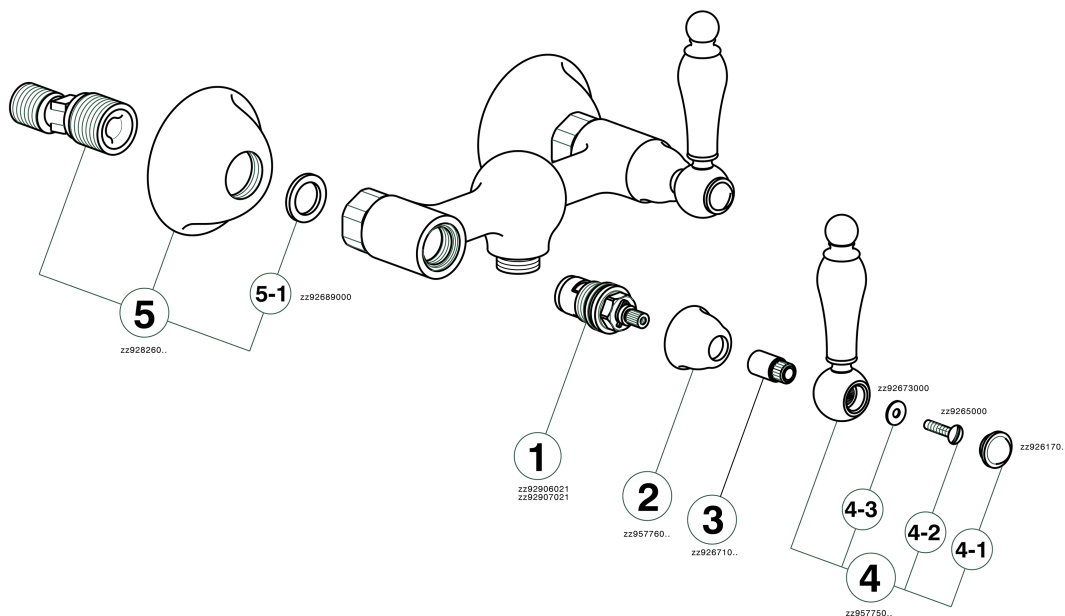

TS000441

<https://es.cisal.it/ducha-arcana-toscana-ts000441>

2024-11-21