

Parte externa termostático ducha emp. 2 salidas ARCANA CERAMIC_AC018100

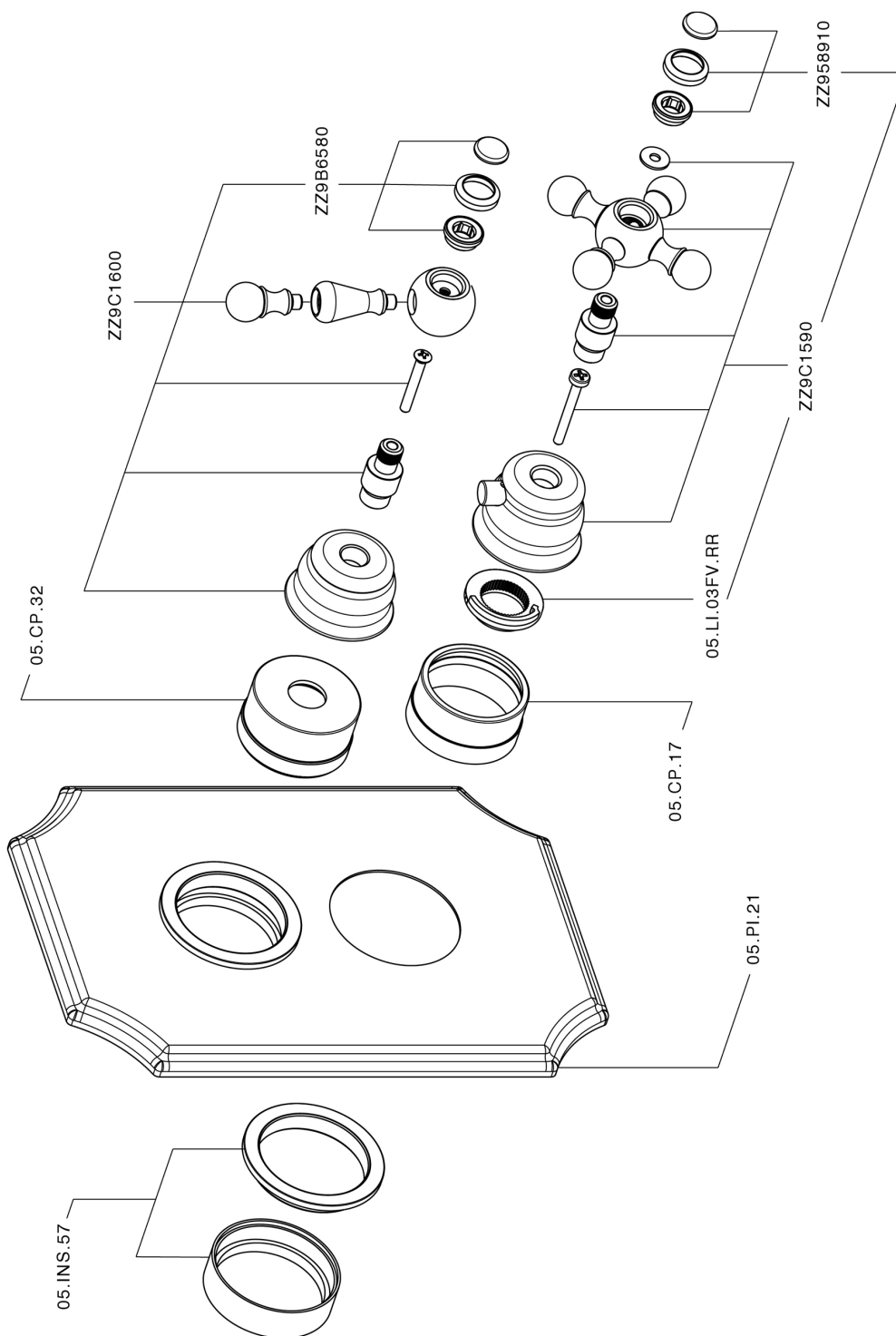

AC018100

<https://es.cisal.it/parte-externa-termostatico-ducha-emp-2-salidas-arcana-ceramic-ac018100>

Parte empotrada termostático ducha 2 salidas EMPOTRADO_ZA018101

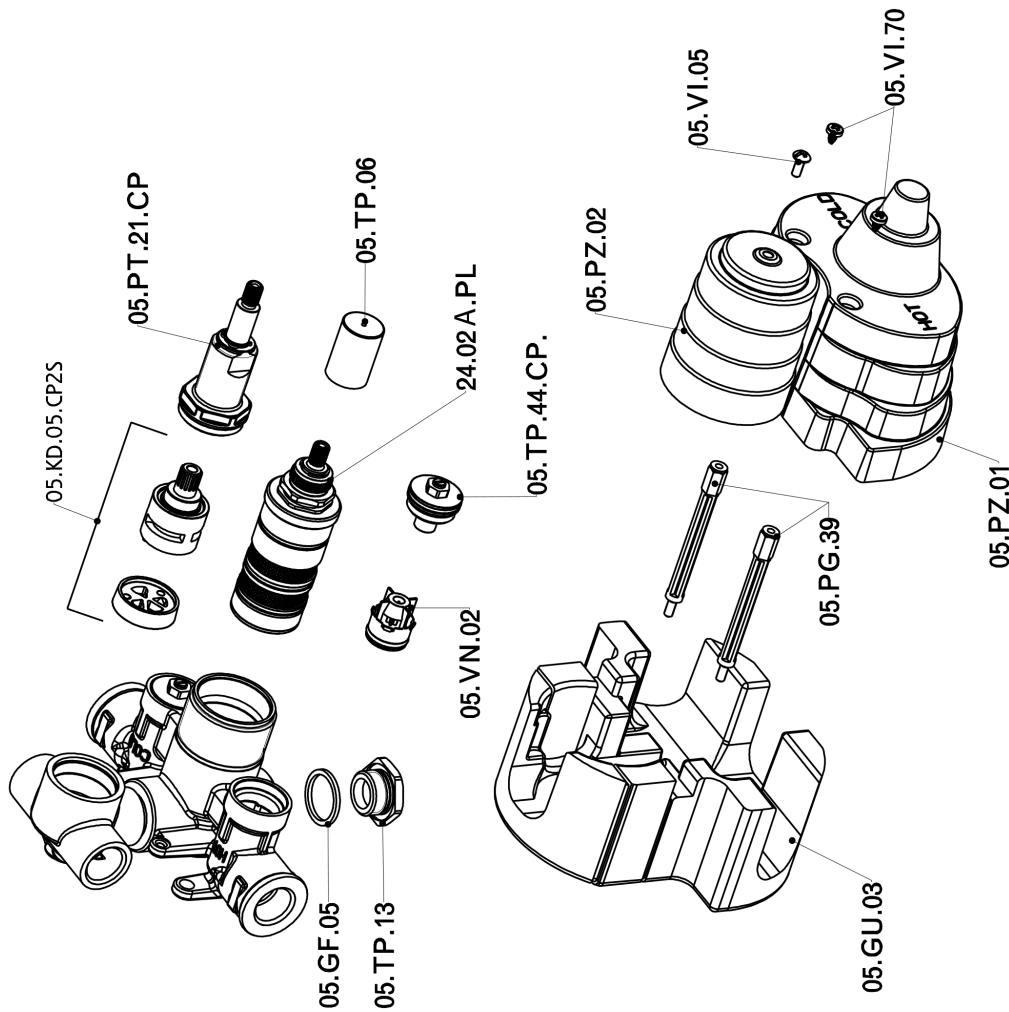

ZA018101

<https://es.cisal.it/parte-empotrada-termostatico-ducha-2-salidas-empotrado-za018101>

2024-12-22