

## Parte externa monomando lavabo de pared TENDER\_C2005511

MODELO **C2005511**

Parte externa monomando lavabo de pared, sin parte empotrada, caño L.200 mm, para art. Easy-Box ZA002450-ZA025510



ACABADOS DISPONIBLES



CARACTERÍSTICAS

Instalación	<b>Empotrado</b>
Empotrado 1	<b>ZA002450</b>

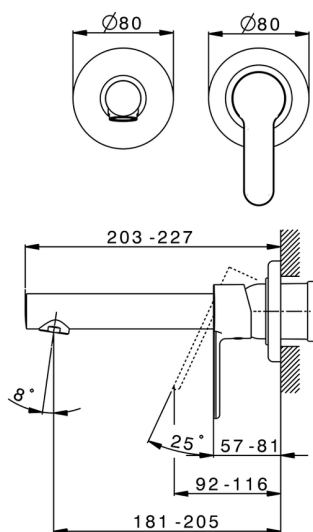

## Parte externa monomando lavabo de pared TENDER\_C2005511

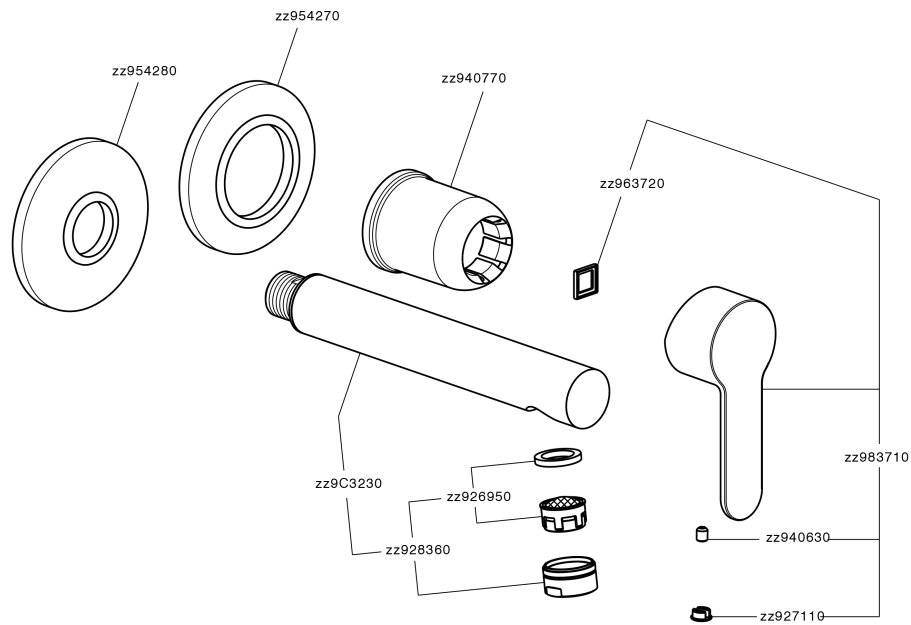

C2005511

<https://es.cisal.it/parte-externa-monomando-lavabo-de-pared-tender-c2005511>

2026-06-14