

## Alargador +50 mm COMPLEMENTOS\_ZA008081

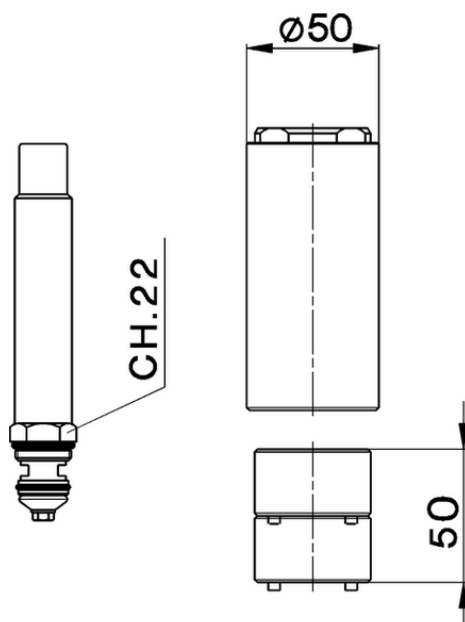

ZA008081

<https://es.cisal.it/alargador-50-mm-complementos-za008081>

2026-05-03