

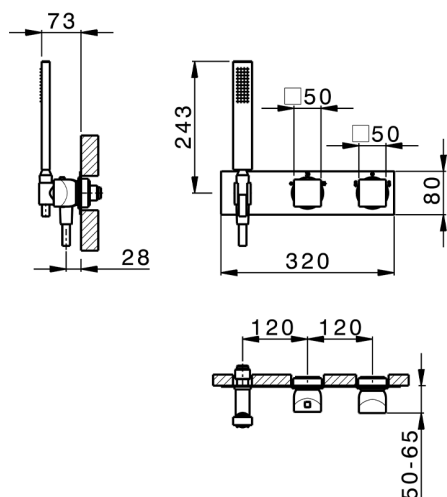









Parte externa termostático ducha emp. 2 salidas HI-RISE_RI019640



MODELO **RI019640**

Parte externa termostático ducha emp.2 salidas,con deviasstop 2 salidas,duchita una función minimalista 35x15 mm Latón,flexible liso SUPREME 150 cm

ACABADOS DISPONIBLES

-  **21** 21 Cromo
-  **24** 24 Oro
-  **2F** 2F Niquel Cepillado
-  **2W** 2W Oro Cepillado
-  **40** 40 Negro Mate
-  **4Q** 4Q Blanco Mate
-  **5G** 5G Oro Rosa
-  **6V** 6V Blanco Mate/Niquel Cepillado
-  **6X** 6X Blanco Mate/Oro Cepillado
-  **7W** 7W Negro Mate/Oro Cepillado



Termostático

El termostático Cisal es tu gestor personal del agua, ayudándote a manejar, controlar y ahorrar agua y energía.

CARACTERÍSTICAS

Instalación	Empotrado
Empotrado 1	ZA019340



Parte empotrada termostático ducha 2 salidas EMPOTRADO_ZA019340

MODELO **ZA019340**

Parte empotrada termostático ducha 2 salidas, sin parte externa

ACABADOS DISPONIBLES

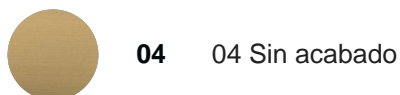

CARACTERÍSTICAS

Recambio Cartucho **24.04A.PP**

Empotrado **1**

Cartucho Termostático Plus P 8X20

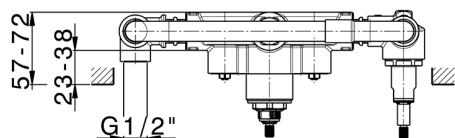
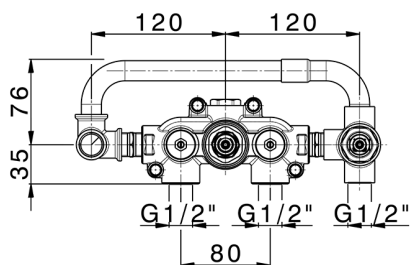
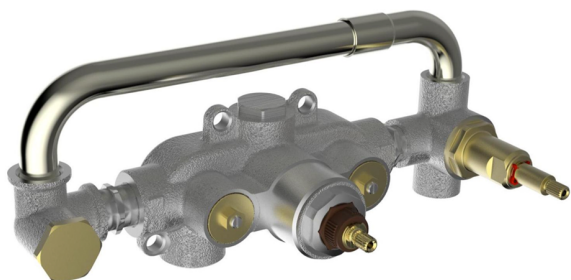

Termostático

El termostático Cisal es tu gestor personal del agua, ayudándote a manejar, controlar y ahorrar agua y energía.



2026-06-14