

Bañera monomando empotrada WAVE_WA001100

cisal

WA 00110

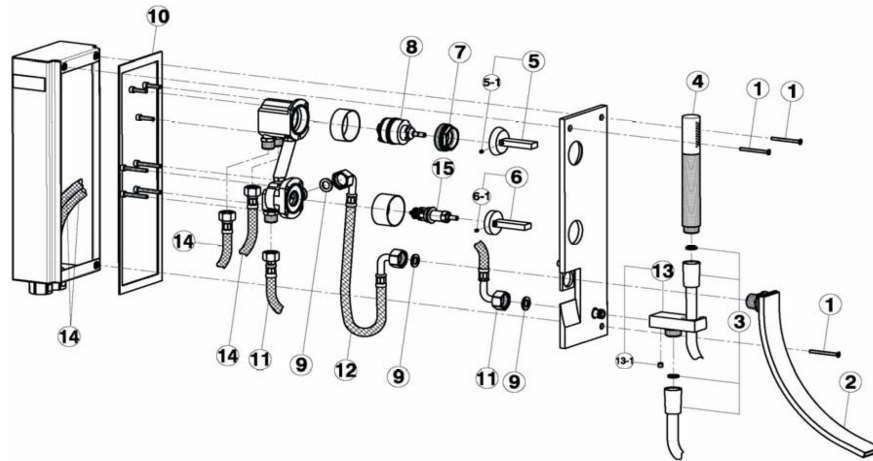
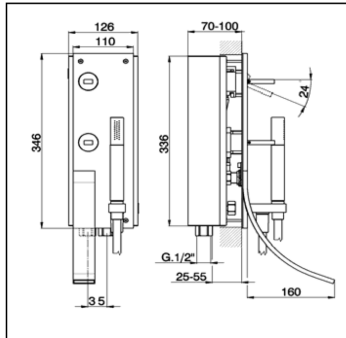

NR.	DESCRIZIONE DESCRIPTION BESCHREIBUNG DESCRIPTION	N.CODICE CODE NO. WERSKNR. NR.CODE	NR.	DESCRIZIONE DESCRIPTION BESCHREIBUNG DESCRIPTION	N.CODICE CODE NO. WERSKNR. NR.CODE	NR.	DESCRIZIONE DESCRIPTION BESCHREIBUNG DESCRIPTION	N.CODICE CODE NO. WERSKNR. NR.CODE
1	Vite M.4x45 Screw M.4x45 Schraube M.4x45 Vis M.4x45	ZZ944920	6	Leva per deviazione automatica Lever for automatic diverter Hebel fuer automatische Umstellung Levier pour inverseur automatique	ZZ944980	11	Flessibile 350 G.3/8"F x G.1/2"F Flex 350 G.3/8"F x G.1/2"F Anschluss Schlauch 350 G.3/8"FxG.1/2"F Flex 350 G.3/8"F x G.1/2"F	ZZ944930
2	Bocca di erogazione Bath spout Wanneneinlauf Bec déverseur	ZZ944960	6-1	Grano punta plana inox M.4x4 Screw-stainless steel M.4x4 Madenschraube M.4x4 Vis speciale inox M.4x4	ZZ933280	12	Flessibile 1/2"F 90° 1/2"F 90° Flex 1/2"F 90° 1/2"F 90° Anschluss Schlauch 1/2"F 90° 1/2"F 90° Flex 1/2"F 90° 1/2"F 90°	ZZ945030
3	Flex PVC 150 cm Ø14 1/2"x1/2" conico Braueschl. PVC 150 cm Ø14 1/2"x1/2" Flex.PVC 150 cm Ø14 1/2"x1/2"	ZZ933040	7	Calotta bloccaggio cartuccia Nut for mixing valve Mutter f/Kartusche Ecrou pour cartouche	ZZ944880	13	Supporto doccia Shower holder Brausehalter Support de douche	ZZ945010
4	Doccia minimale Minimal handshower Handbrause minimal Douchette minimal	DS014090	8	Cartuccia monocomando Mixing valve Kartusche Cartouche mitigeurs	ZZ931970	13-1	Grano punta coppa inox M.6x6 Screw-stainless steel M.6x6 Madenschraube M.6x6 Vis speciale inox M.6x6	ZZ933370
5	Lever "WA" Hebel "WA" Levier "WA"	ZZ944870	9	Guarnizione fibra 18,5x11x2 Gasket rubber 18,5x11x2 Fiberdichtung 18,5x11x2 Joint en fibre 18,5x11x2	ZZ927140	14	Flex M.11x1 3/8" L.365 Anschluss Schlauch M.11x1 3/8" L.365 Flex M.11x1 3/8" L.365	ZZ928420
5-1	Grano punta plana inox M.4x4 Screw-stainless steel M.4x4 Madenschraube M.4x4 Vis speciale inox M.4x4	ZZ933280	10	Guarnizione per piastra Gasket for plate Dichtung fuer Platte Joint pour plaque	ZZ944970			

WA001100

<https://es.cisal.it/banera-monomando-empotrada-wave-wa001100>

2026-05-01