

Baño/ducha monomando empotrado WAVE_WA000210

MODELO **WA000210**

Baño/ducha monomando empotrado, comprensivo de parte empotrada, desviador automático 2 salidas, duchita una función minimal de Latón, flexible PVC 150 cm



ACABADOS DISPONIBLES

-  **21** 21 Cromo
-  **2F** 2F Niquel Cepillado
-  **2Q** 2Q Black Titanium

CARACTERÍSTICAS

Recambio Cartucho **ZZ93197000**

Cartucho monocomando Joystick 38 mm

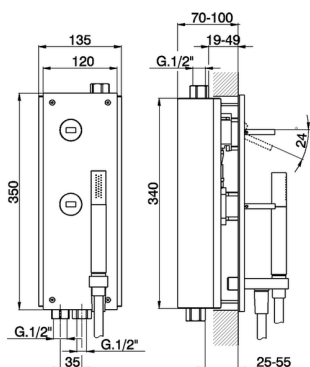

Baño/ducha monomando empotrado WAVE_WA000210

cisal

WA 00021

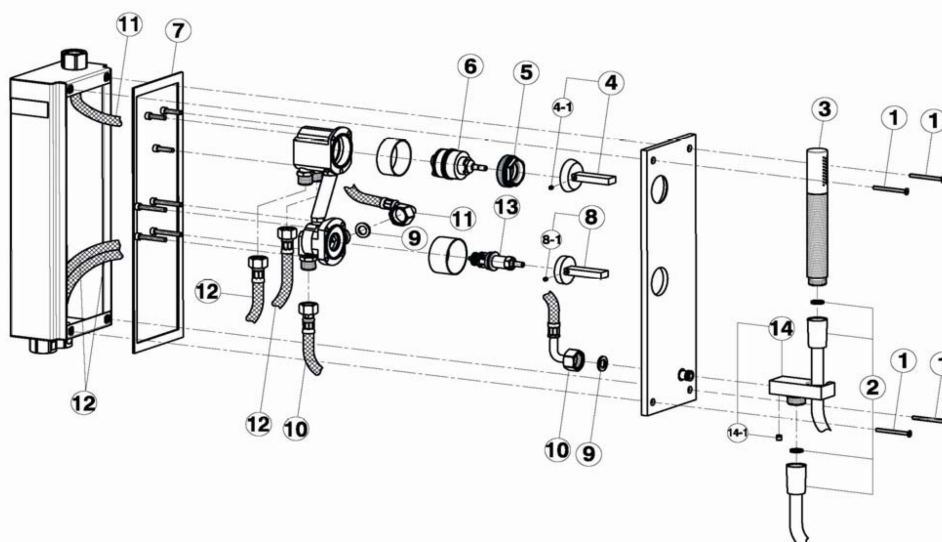
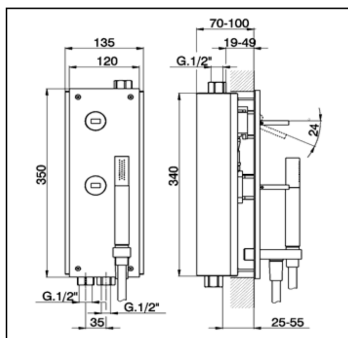

NR.	DESCRIZIONE DESCRIPTION BESCHREIBUNG DESCRIPTION	N.CODICE CODE NO. WERSKNR. NR.CODE	NR.	DESCRIZIONE DESCRIPTION BESCHREIBUNG DESCRIPTION	N.CODICE CODE NO. WERSKNR. NR.CODE	NR.	DESCRIZIONE DESCRIPTION BESCHREIBUNG DESCRIPTION	N.CODICE CODE NO. WERSKNR. NR.CODE
1	Vite M.4x45 Screw M.4x45 Schraube M.4x45 Vis M.4x45 Flex PVC 150 cm Ø14 1/2"x1/2" conico	ZZ944920	6	Cartuccia monomando Mixing valve Kartusche Cartouche mitigeurs Guarnizione per piastra	ZZ931970	11	Flessibile 350 M.11x1M x G.1/2" F 9 Flex 350 M.11x1M x G.1/2" F 9 Anschlusschl.350 M.11x1M x G.1/2" F 9 Flex 350 M.11x1M x G.1/2" F 9	ZZ944990
2	Flex PVC 150 cm Ø14 1/2"x1/2" Braueschl. PVC 150 cm Ø14 1/2"x1/2" Flex.PVC 150 cm Ø14 1/2"x1/2"	ZZ933040	7	Guarnizione per piastra Gasket for plate Dichtung fuer Platte Joint pour plaque	ZZ944970	12	Flessibile 270 G.3/8" F x M.11x1M Flex 270 G.3/8" F x M.11x1M Anschlusschl.270 G.3/8" F x M.11x1M Flex 270 G.3/8" F x M.11x1M	ZZ944940
3	Doccia minimale Minimal handshower Handbrause minimal Douchette minimal	DS014090	8	Leva per deviazione automatica Lever for automatic diverter Hebel fuer automatische Umstellung Levier pour inverseur automatique	ZZ944980	13	Valvola deviatrice Diverter's valve Umstellventil Cartouche pour inverseur	ZZ945000
4	Leva monomando "WA" Lever "WA" Hebel "WA" Lever "WA"	ZZ944870	8-1	Grano punta piana inox M.4x4 Screw-stainless steel M.4x4 Madenschraube M.4x4 Vis speciale inox M.4x4	ZZ933280	14	Supporto doccia Shower holder Brausehalter Support de douche	ZZ945010
4-1	Grano punta piana inox M.4x4 Screw-stainless steel M.4x4 Madenschraube M.4x4 Vis speciale inox M.4x4	ZZ933280	9	Guarnizione fibra 18,5x11x2 Gasket rubber 18,5x11x2 Fiberdichtung 18,5x11x2 Joint en fibre 18,5x11x2	ZZ927140	14-1	Grano punta coppa inox M.6x6 Screw-stainless steel M.6x6 Madenschraube M.6x6 Vis speciale inox M.6x6	ZZ933370
5	Calotta bloccaggio cartuccia Nut for mixing valve Mutter f/Kartusche Ecrour pour cartouche	ZZ944880	10	Flessibile 350 G.3/8" F x G.1/2" F Flex 350 G.3/8" F x G.1/2" F Anschluss Schlauch 350 G.3/8" F x G.1/2" F Flex 350 G.3/8" F x G.1/2" F	ZZ944930			

WA000210

<https://es.cisal.it/bano-ducha-monomando-empotrado-wave-wa000210>

2026-05-01