

Fregadero monomando ducha extraíble KITCHEN_M3002570



MODELO **M3002570**

Fregadero monomando ducha extraíble, caño giratorio, duchita 2 funciones, flexible nylon 150 cm

ACABADOS DISPONIBLES



21 21 Cromo

CARACTERÍSTICAS

Recambio Cartucho **ZZ95274000**

Cartucho Monomando 40 mm

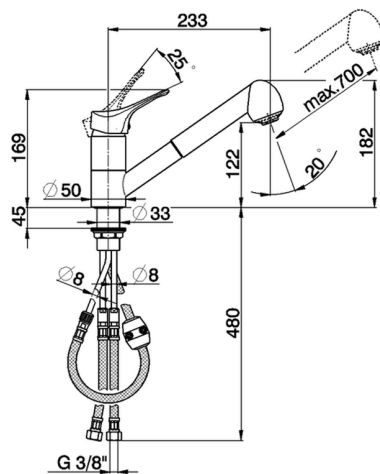

Fregadero monomando ducha extraíble KITCHEN_M3002570

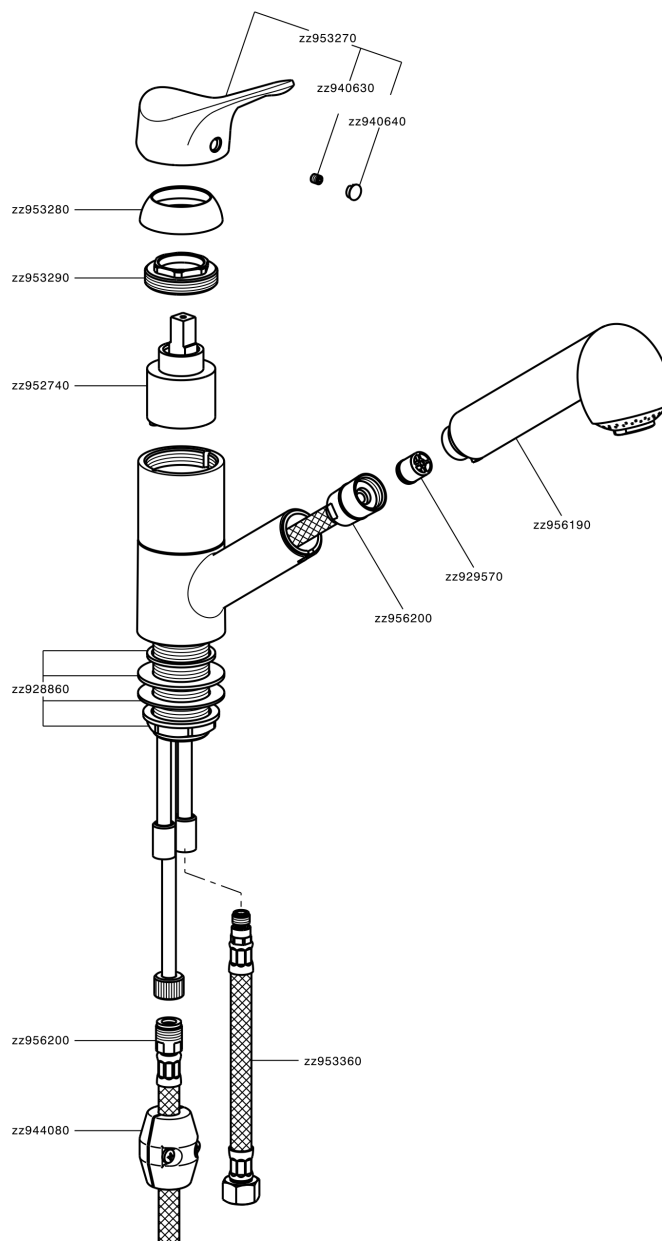

M3002570

<https://es.cisal.it/fregadero-monomando-ducha-extraible-kitchen-m3002570>

2026-06-20