

Parte externa para termostático empotrado PUSH&SHOWER_PS1G1030

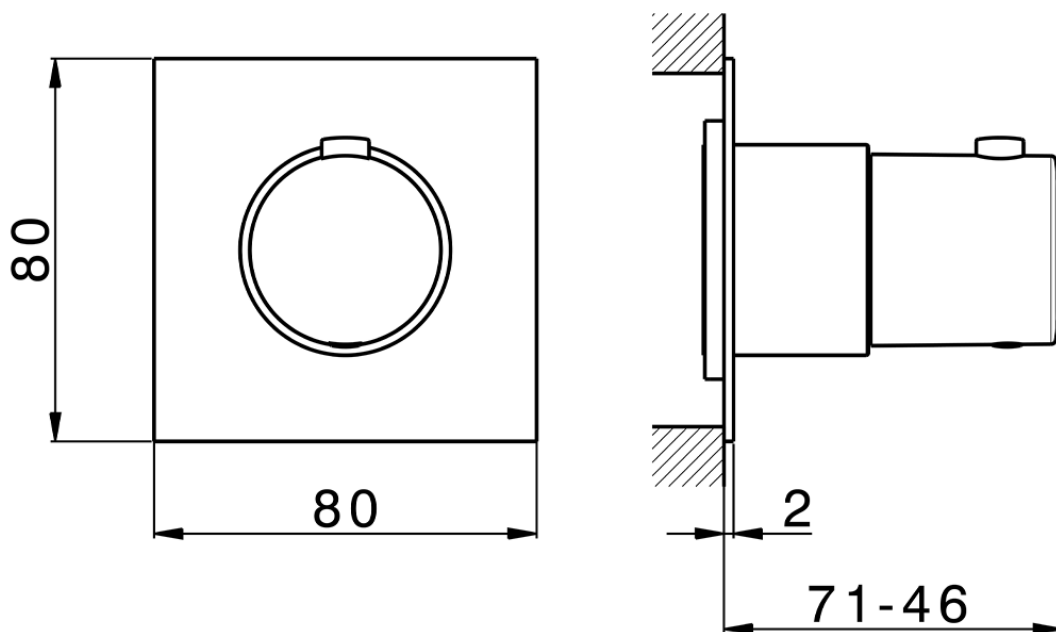

PS1G1030

<https://es.cisal.it/parte-externa-para-termostatico-empotrado-pushshower-ps1g1030>

2026-06-15