

Panel de ducha monomando 2 funciones WELLNESS_ZS005030

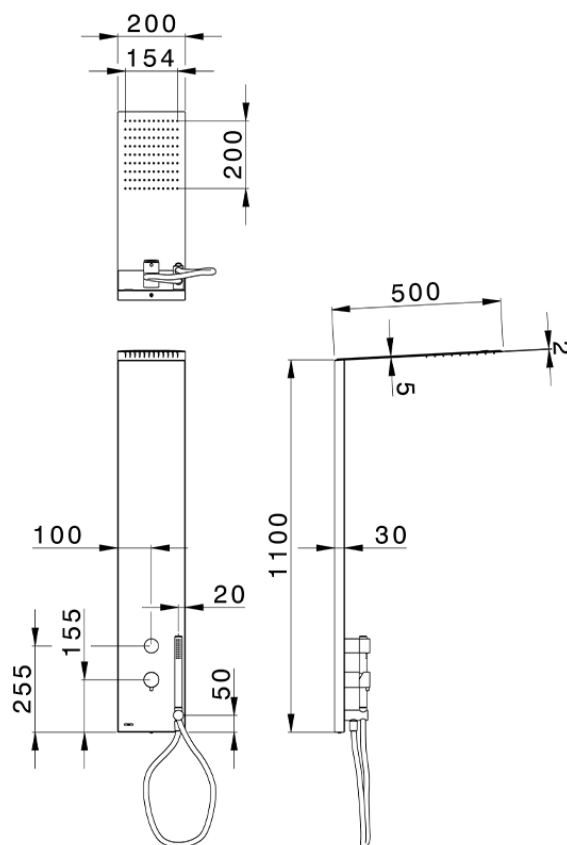

ZS005030

<https://es.cisal.it/panel-de-ducha-monomando-2-funciones-wellness-zs005030>

2026-06-14