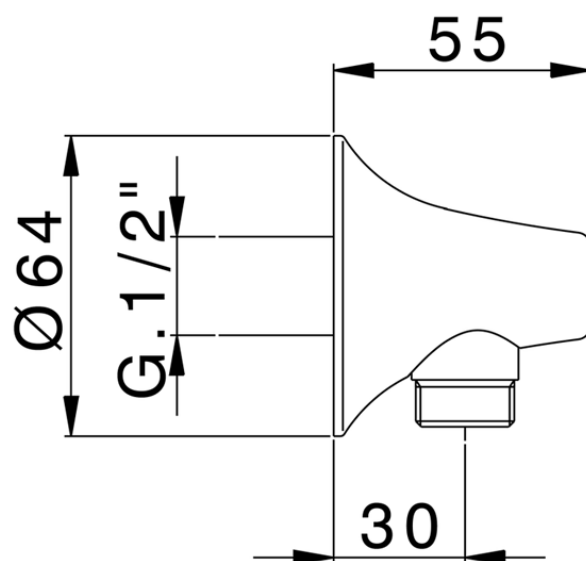

**Toma de agua VITA\_VI017000**

VI017000

<https://es.cisal.it/toma-de-agua-vita-vi017000>

2026-06-19