

## Parte externa termostático ducha emp. 2 salidas WAVE\_WE019100

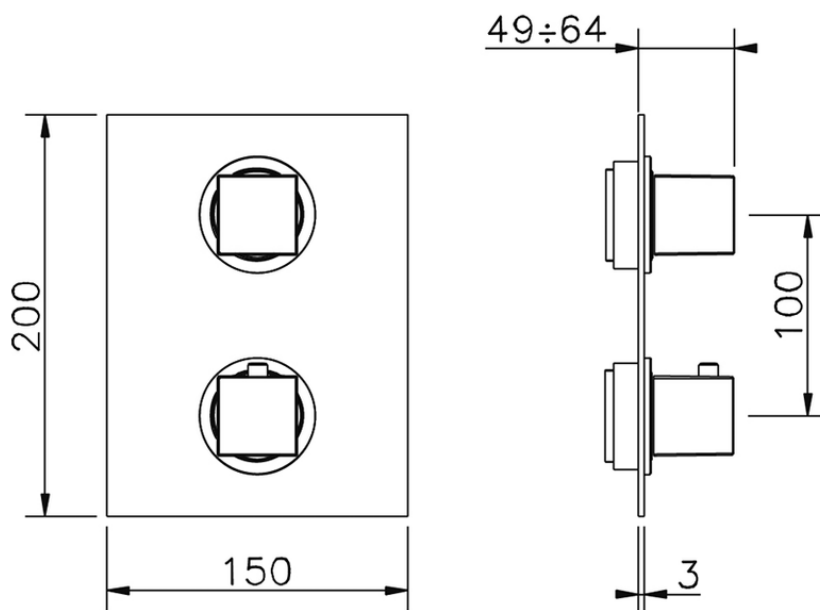

WE019100

<https://es.cisal.it/parte-externa-termostatico-ducha-emp-2-salidas-wave-we019100>

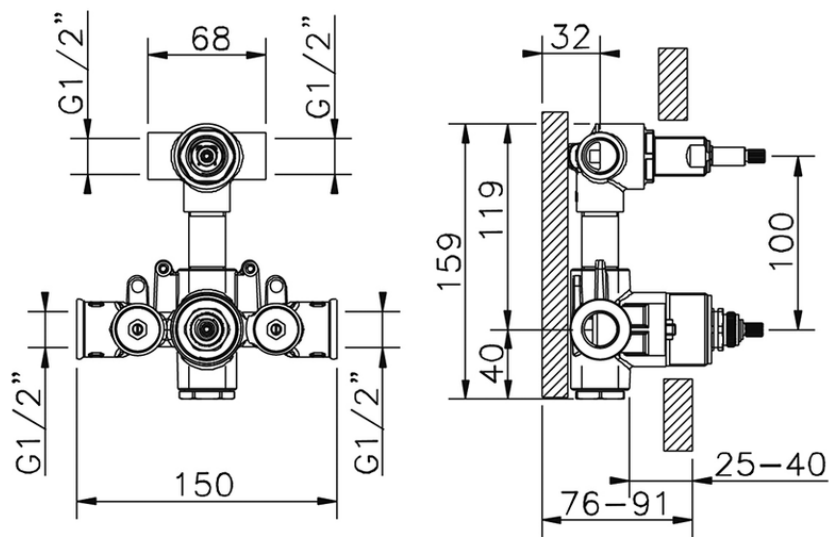

ZA019101

<https://es.cisal.it/parte-empotrada-termostatico-ducha-2-salidas-empotrado-za019101>

2026-06-15