

Fregadero monomando de pared CLINIC_CL000401

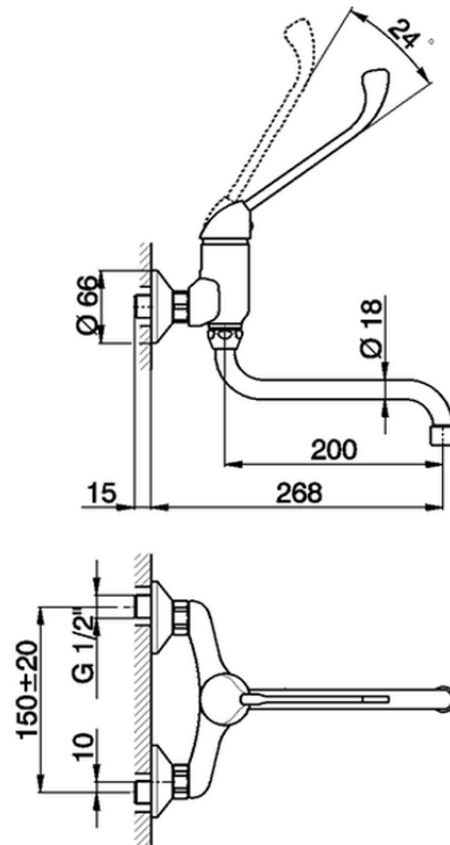

CL000401

<https://es.cisal.it/fregadero-monomando-de-pared-clinic-cl000401>

2026-06-15