

Parte externa monomando de suelo HI-RISE_RI014514

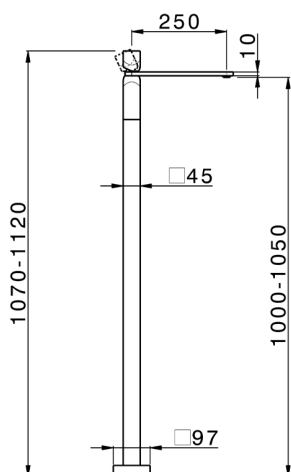
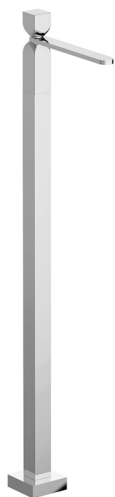

MODELO **RI014514**

Parte externa monomando de suelo, sin parte empotrada, para art. ZA004510

ACABADOS DISPONIBLES

-  **21** 21 Cromo
-  **24** 24 Oro
-  **2F** 2F Niquel Cepillado
-  **2W** 2W Oro Cepillado
-  **40** 40 Negro Mate
-  **4Q** 4Q Blanco Mate
-  **5G** 5G Oro Rosa
-  **6V** 6V Blanco Mate/Niquel Cepillado
-  **6X** 6X Blanco Mate/Oro Cepillado
-  **7W** 7W Negro Mate/Oro Cepillado

CARACTERÍSTICAS

Recambio Cartucho **ZZ96550000**
Cartucho Monomando 25 mm
 Instalación **Empotrado**
 Empotrado 1 **ZA004510**



Parte empotrada monomando free-standing EMPOTRADO_ZA004510

MODELO **ZA004510**

Parte empotrada monomando free-standing

ACABADOS DISPONIBLES

 **04** 04 Sin acabado

CARACTERÍSTICAS

Empotrado **1**

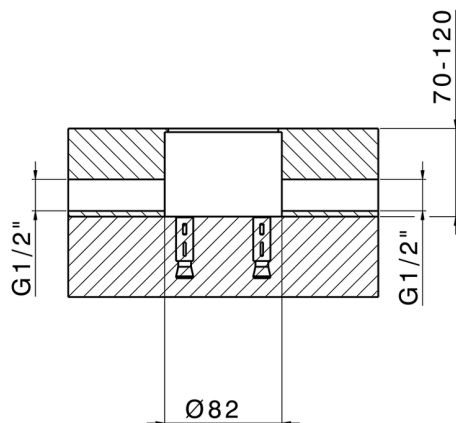

2026-06-16