





Parte externa lavabo de pared NUOVA LESS_LN013513

MODELO **LN013513**

Parte externa lavabo de pared, sin parte empotrada, para art. ZA033511

ACABADOS DISPONIBLES

-  **21** 21 Cromo
-  **2F** 2F Níquel Cepillado
-  **40** 40 Negro Mate
-  **4Q** 4Q Blanco Mate

CARACTERÍSTICAS

Instalación **Empotrado**
Empotrado 1 **ZA033511**

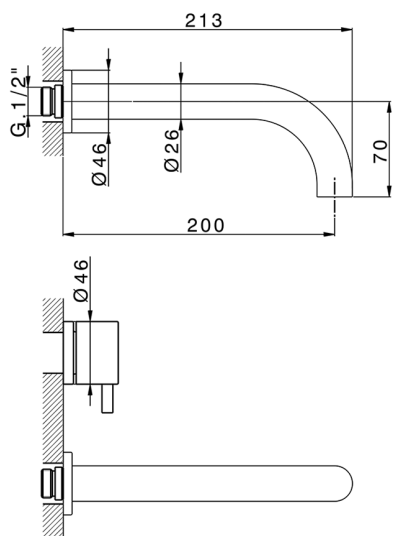

Parte empotrada lavabo de pared EMPOTRADO_ZA033511

MODELO **ZA033511**

Parte empotrada lavabo de pared, con montura de derecha y montura de izquierda

ACABADOS DISPONIBLES



04 04 Sin acabado

CARACTERÍSTICAS

Empotrado **1**



2026-04-30