







Bañera monomando ARCANA ROYAL_AY000130

MODELO **AY000130**

Bañera monomando, sin conjunto ducha, conexión para flexible 1/2" M



ACABADOS DISPONIBLES

-  **21** 21 Cromo
-  **24** 24 Oro
-  **26** 26 Cobre Viejo
-  **27** 27 Bronce Viejo
-  **2A** 2A Niquel Satinado Cepillado
-  **74** 74 Cromo/Oro

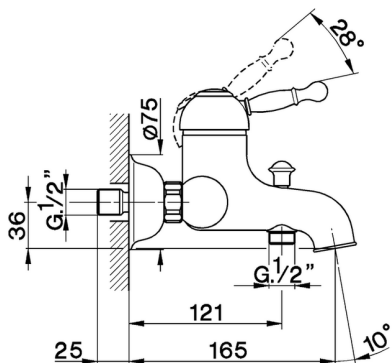

CARACTERÍSTICAS

Recambio Cartucho **ZZ92909000**

Cartucho Monomando 43 mm



Bañera monomando ARCANA ROYAL_AY000130

cisal

AY 00012 (AY 00013)

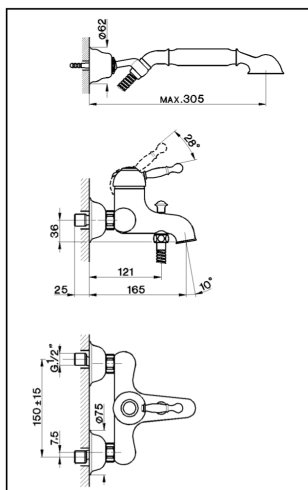

- Monocomando vasca
- Single lever bath mixer
- Einhand-Badebatterie DN 15
- Mitigeur bain/douche

bar	PORTATA BOCCA DI EROGAZIONE * SPOUT FLOW RATE DURCHFLOSS WANNENEINLAUF DEBIT BEC DEVERSEUR l/min.
0,5	9,5
1	13
2	18,5
3	22,5
4	26
5	29

* con resistenza silenziosa della classe di portata C (30 l/min. a 3 bar)
with hydraulic resistance of flow rate class C (30 l/min. at 3 bar)
mit geräuscharmen Widerstand der Durchflussklasse C (30 l/min. bei 3 bar)
avec aérateur classe C (30 l/min. à 3 bar)

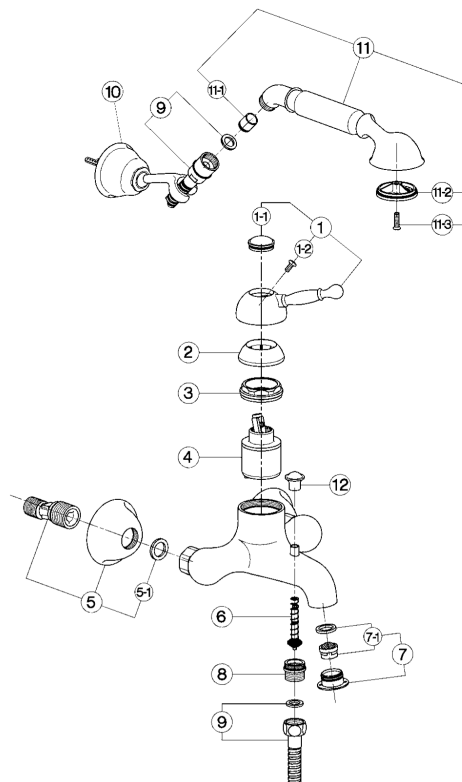

NR.	DESCRIZIONE DESCRIPTION BESCHREIBUNG DESCRIPTION	N. CODICE CODE NO. WERKSNR. NR. CODE	NR.	DESCRIZIONE DESCRIPTION BESCHREIBUNG DESCRIPTION	N. CODICE CODE NO. WERKSNR. NR. CODE	NR.	DESCRIZIONE DESCRIPTION BESCHREIBUNG DESCRIPTION	N. CODICE CODE NO. WERKSNR. NR. CODE
1	Leva monocomando "AY" Lever "AY" Hebel "AY" Levier "AY"	ZZ 90370 0	7	Bordino con aeratore M. 24x1 "AR" Cascade Overfill with mousseur M.24x1 "AR" Cascade Peñator M.24x1 "AR" Cascade Garniture avec mousseur M.24x1 "AR" Cascade	ZZ 93395 0	11-3	Vite di fissaggio diffusore per doccia in ABS Fixing screw for spray-kit ABS handshower Befestigungsschraube f. Einsatz l.Brause in ABS Vis de fixation diffuseur pour douchette en ABS	ZZ 93401 0
1-1	Piacchetta per leva "AY" Cap for lever "AY" Abdeckkappe l/Hebel "AY" Plaquette levier "AY"	ZZ 93048 0	7-1	Cartuccia per aeratore M. 24x1 Cascade Mousseur cartridge M.24x1 Cascade Kart. l/Peñator M.24x1 Cascade Cartouche x mousseur M.24x1 Cascade	ZZ 93396 0	12	Pomolo per deviazione Knob for diverter Zugknopf Umsteller Pommeau pour inverseur	ZZ 93394 0
1-2	Vite M.4,5x15 tb. tc. Screw M.4,5x15 Schraube M.4,5x15 Vis M.4,5x15	ZZ 92641 0	8	Attacco flessibile Flexible connection Flex Anschluss Raccord flex	ZZ 93141 0			
2	Copricartuccia senza ideogrammi Escutcheon cartridge without ideogram Abdeckkappe ohne Ideogramm Couvre-cartouche sans ideogramme	ZZ 92718 0	9	Flessibile 150 cm Ø14 1/2"x1/2" DA conico Flex 150 cm Ø14 1/2"x1/2" conic Brauseschlauch 150 cm Ø14 1/2"x1/2" Flex 150 cm Ø14 1/2"x1/2"	ZA 00901 0			
3	Calotta bloccaggio cartuccia piccola Nut for mixing valve-small Mutter l/Kartusche Ecrou pour cartouche	ZZ 92603 0	10	Supporto duplex esterno "AR" Hook handshower "AR" Wandhalter l/ "AR" Support mural "AR"	ZZ 90082 0			
4	Cartuccia monocomando piccola Mixing valve - small size Kartusche Cartouche mitigeurs	ZZ 92909 0	11	Doccia per gruppo vasca "AR" Handshower "AR" Handbrause-WB-"AR" Douchette "AR"	ZZ 90078 0			
5	Eccentrico con rosone "AC" Eccentric connection with escutcheon "AC" S - Anschluss m.Rosette "AC" Eccentrique + rosace "AC"	ZZ 92826 0	11-1	Valvola anti-ritorno Ø15 per doccia Back-flow valve Ø15 Durchflussverhinderer Ø15 Clapot anti-retour Ø15	ZZ 92956 0			
5-1	Guarnizione NBR 90 SH, 24x16x2,7 Gasket NBR 90 SH, 24x16x2,7 Dichtung NBR 90 SH, 24x16x2,7 Joint NBR 90 SH, 24x16x2,7	ZZ 92689 0	11-2	Diffusore doccia "AR" Spray-kit handshower "AR" Einsatz l/Brause "AR" Diffuseur douchette "AR"	ZZ 90544 0			
6	Asta deviazione completa Complete diverting rod Umstellung Tige inverseur complète	ZZ 93314 0	11-3	Vite di fissaggio diffusore per doccia in ottone Fixing screw for spray-kit handshower Befestigungsschraube f.Einsatz l.Br. in Messing Vis fixation diffuseur pour douchette en laiton	ZZ 92640 0			

AY.2

AY000130

<https://es.cisal.it/banera-monomando-arcana-royal-ay000130>

2024-12-22