

Parte externa llave de paso GRACE_GS003310

MODELO **GS003310**

Parte externa llave de paso, sin parte empotrada, para art. ZA003330-ZA003340

ACABADOS DISPONIBLES

-  **21** 21 Cromo
-  **2F** 2F Niquel Cepillado
-  **2W** 2W Oro Cepillado
-  **5H** 5H Dark Brass Brushed
-  **5L** 5L Brushed Black Titanium
-  **6T** 6T Cromo/Negro Mate

CARACTERÍSTICAS

Instalación	Empotrado
Empotrado 2	ZA003340
	ZA003330

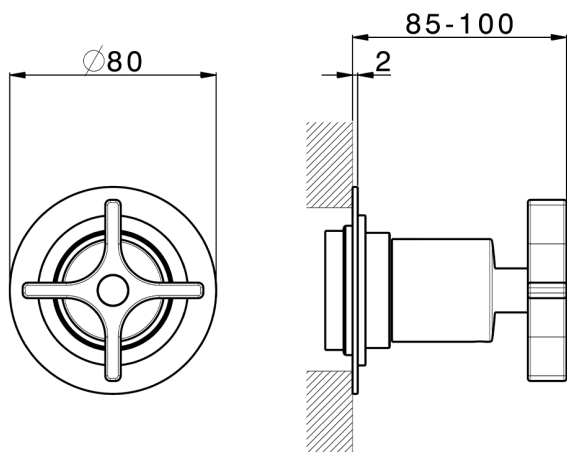
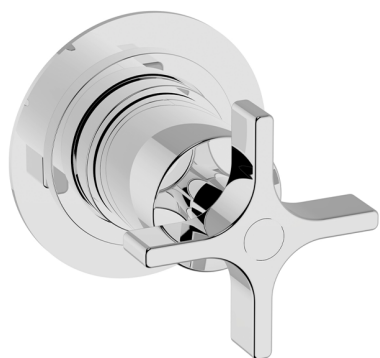

Parte empotrada llave de paso 1/2" EMPOTRADO_ZA003340

MODELO **ZA003340**

Parte empotrada llave de paso 1/2", apert. sentido contrario agujas del reloj

ACABADOS DISPONIBLES



04 04 Sin acabado

CARACTERÍSTICAS

Empotrado **1**

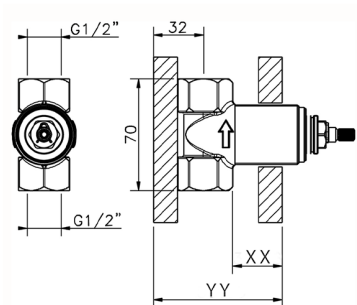

Piastra/Plate/Plaque/Platte/Placa
 2-3mm: XX 31-46 YY 80-95
 10mm: XX 25-40 YY 76-91



Parte empotrada llave de paso 3/4" EMPOTRADO_ZA003330

MODELO **ZA003330**

Parte empotrada llave de paso 3/4", apert. sentido contrario agujas del reloj



ACABADOS DISPONIBLES



04 04 Sin acabado

CARACTERÍSTICAS

Empotrado **1**

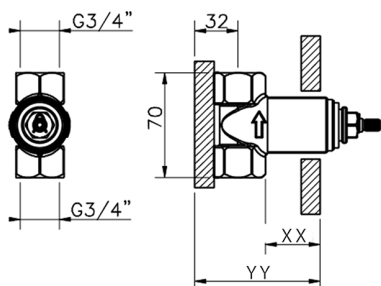

Piastra/Plate/Plaque/Platte/Placa

2-3mm: XX 31-46 YY 80-95

10mm: XX 25-40 YY 76-91



2024-11-21