

Parte externa termostático ducha emp. 2 salidas ROADSTER ACCENT_RA018100

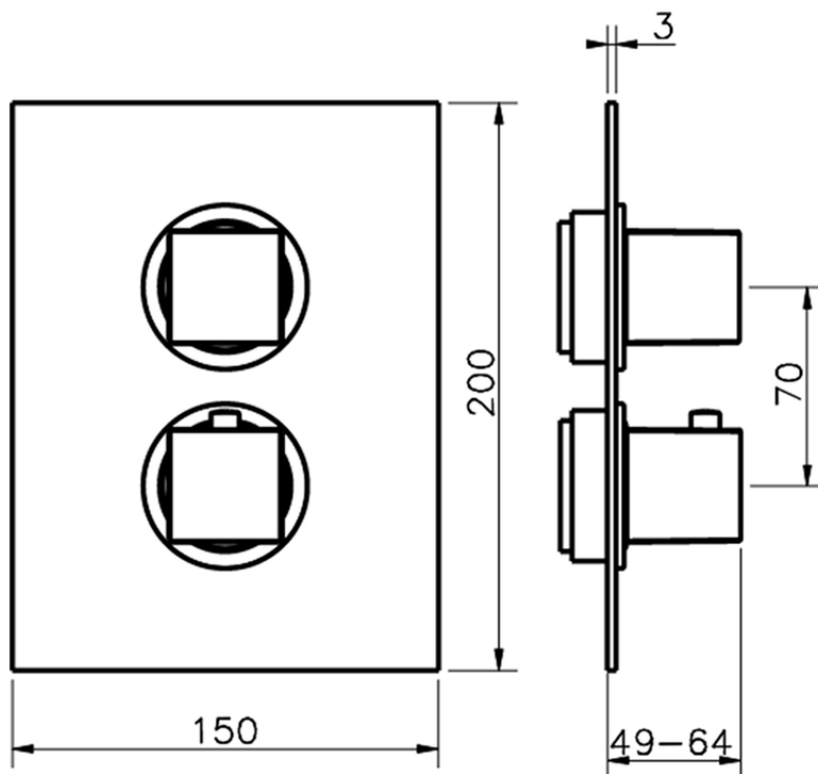

RA018100

<https://es.cisal.it/parte-externa-termostatico-ducha-emp-2-salidas-roadster-accent-ra018100>



Piastra/Plate/Plaque/Platte/Placa

2-3mm: XX 25-40 YY 76-91

10 mm: XX 16-31 YY 65-80

ZA018101

<https://es.cisal.it/parte-empotrada-termostatico-ducha-2-salidas-empotrado-za018101>

2024-11-21