



Parte externa lavabo de pared CHERIE_CX013510

MODELO **CX013510**

Parte externa lavabo de pared, sin parte empotrada, para art. ZA033510

ACABADOS DISPONIBLES

- 
6T 6T Cromo/Negro Mate
- 
7C 7C Oro/Negro Mate
- 
7D 7D Niquel Brillo/Negro Mate
- 
7E 7E Oro Rosa/Negro Mate

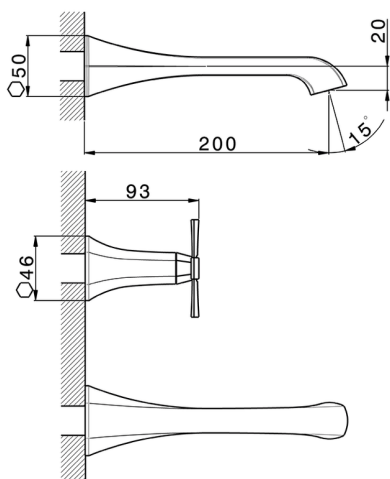
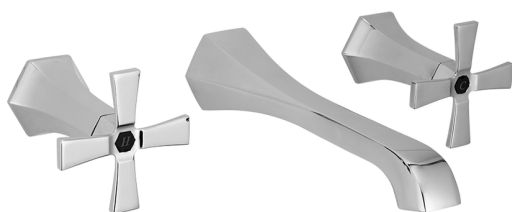

CARACTERÍSTICAS

Instalación	Empotrado
Empotrado 1	ZA033510



Parte externa lavabo de pared CHERIE_CX013510

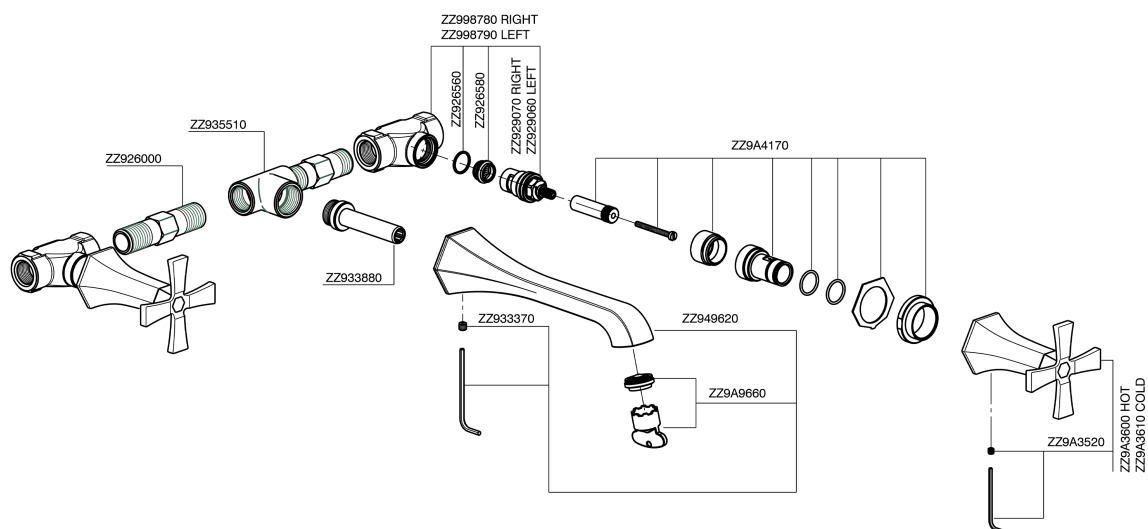

CX013510

<https://es.cisal.it/parte-externa-lavabo-de-pared-cherie-cx013510>

Parte empotrada lavabo de pared EMPOTRADO_ZA033510

MODELO **ZA033510**

Parte empotrada lavabo de pared, con dos monturas de apertura hacia la derecha

ACABADOS DISPONIBLES



CARACTERÍSTICAS

Empotrado **1**



2026-04-30