

## Alargador +25 mm COMPLEMENTOS\_ZA008080

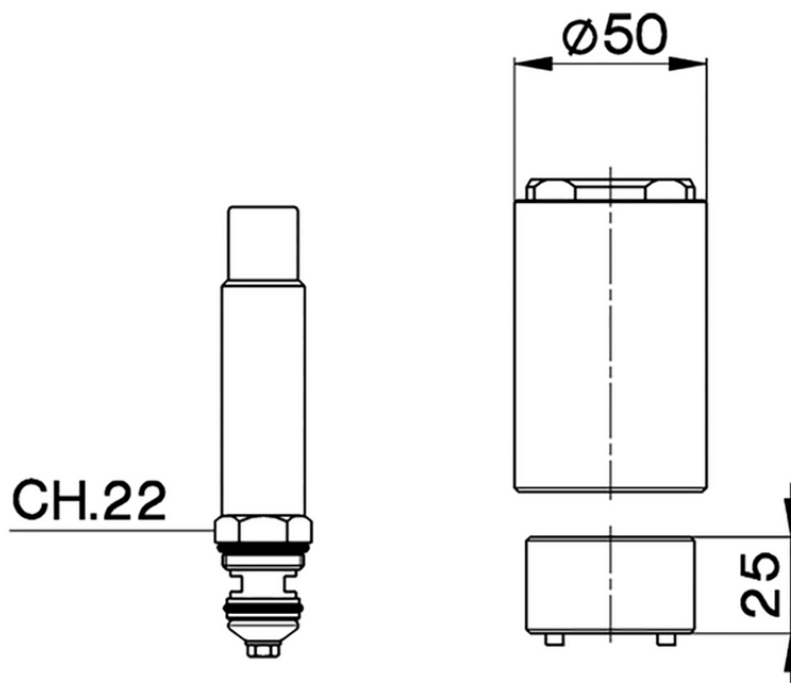

ZA008080

<https://es.cisal.it/alargador-25-mm-complementos-za008080>

2026-06-17