

Parte empotrada termostático ducha 2 salidas EMPOTRADO_ZA019100

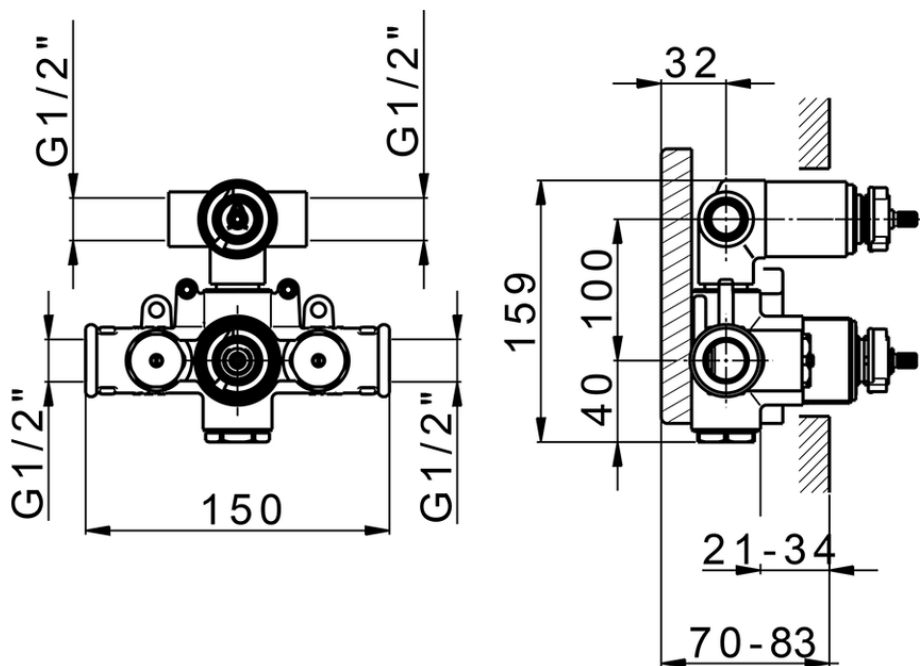

ZA019100

<https://es.cisal.it/parte-empotrada-termostatico-ducha-2-salidas-empotrado-za019100>

2026-06-14