





## Ducha termostática VITA\_VIT01010

MODELO **VIT01010**

Ducha termostática, sin conjunto ducha, conexión para flexible 1/2" M

### ACABADOS DISPONIBLES

-  **21** 21 Cromo
-  **2Q** 2Q Black Titanium
-  **40** 40 Negro Mate
-  **4Q** 4Q Blanco Mate

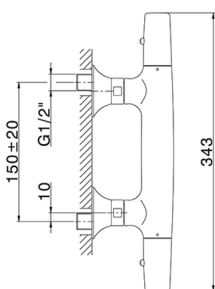
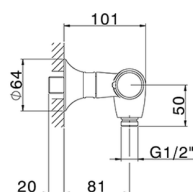

### CARACTERÍSTICAS

Recambio Cartucho **ZZ96551000**

**Cartucho Termostático TMX 25**



#### SafeTouch

El sistema Cisal SafeTouch mantiene el cuerpo de la grifería frío al cuerpo durante el uso.



#### Termostático

El termostático Cisal es tu gestor personal del agua, ayudándote a manejar, controlar y ahorrar agua y energía.



## Ducha termostática VITA\_VIT01010

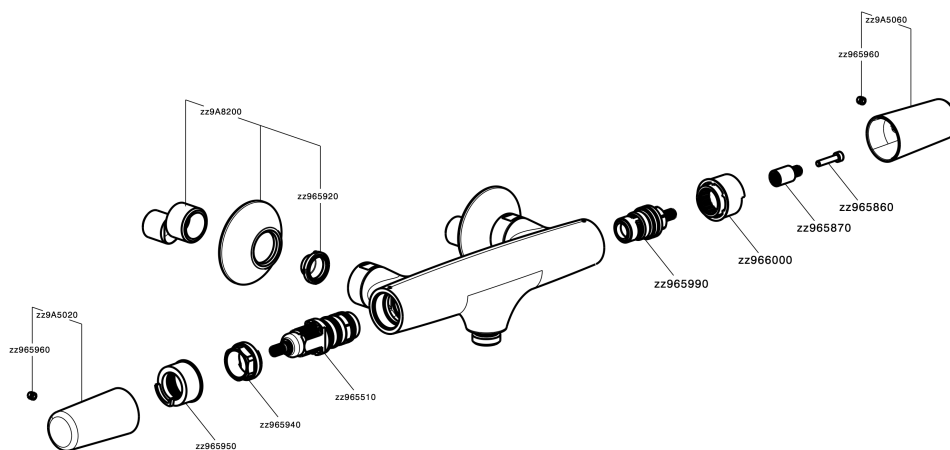

VIT01010

<https://es.cisal.it/ducha-termostatica-vita-vit01010>

2024-12-04