





Ducha termostática VITA_VIT01010

MODELO **VIT01010**

Ducha termostática, sin conjunto ducha, conexión para flexible 1/2" M

ACABADOS DISPONIBLES

-  **21** 21 Cromo
-  **2Q** 2Q Black Titanium
-  **40** 40 Negro Mate
-  **4Q** 4Q Blanco Mate

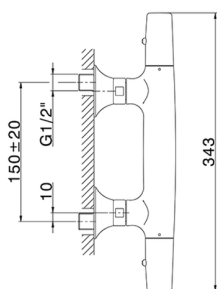
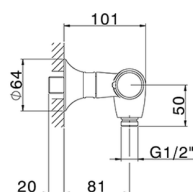

CARACTERÍSTICAS

Recambio Cartucho **ZZ96551000**

Cartucho Termostático TMX 25



SafeTouch

El sistema Cisal SafeTouch mantiene el cuerpo de la grifería frío al cuerpo durante el uso.



Termostático

El termostático Cisal es tu gestor personal del agua, ayudándote a manejar, controlar y ahorrar agua y energía.



Ducha termostática VITA_VIT01010

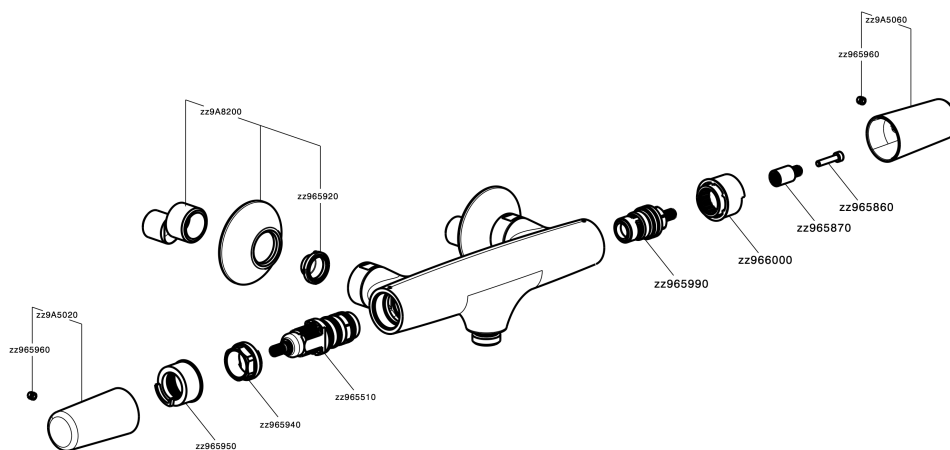

VIT01010

<https://es.cisal.it/ducha-termostatica-vita-vit01010>

2024-12-04