

Not included / Non inclus / δεν συμπεριλαμβάνονται / Não incluído / Non incluso / brak w zestawie
no incluido / не входит до комплекту / neinclus / dahil değildir / Не входит в комплект

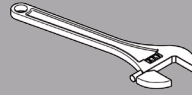

Sostituzione della cartuccia
Cartridge Replacement
Remplacement de la cartouche
Ersatz der Kartusche
Reemplazo del cartucho

1

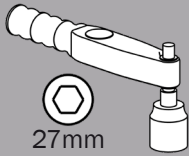
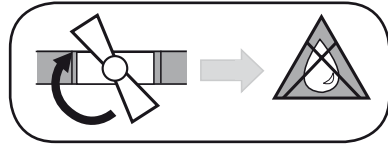

IS.530 Ediz.02.18

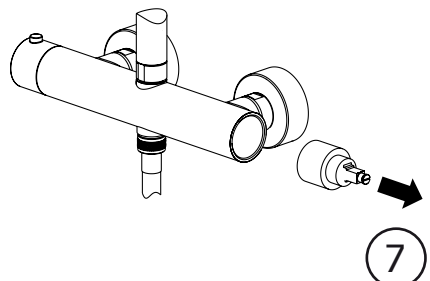
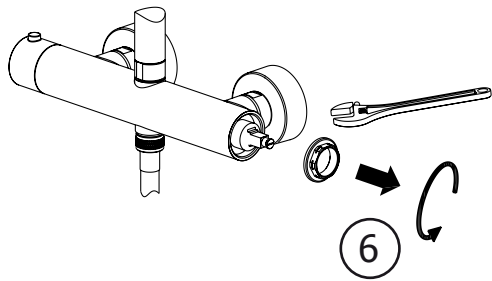
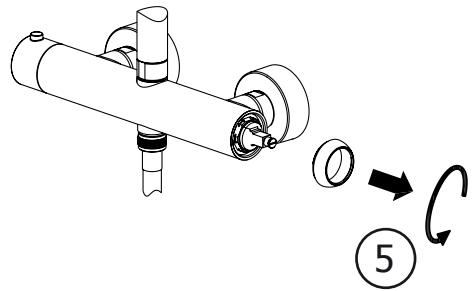
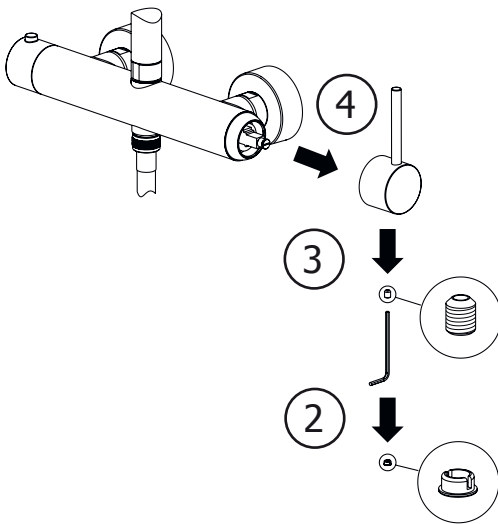

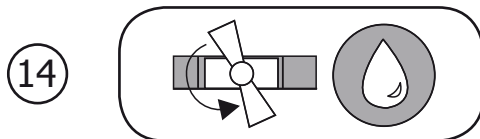
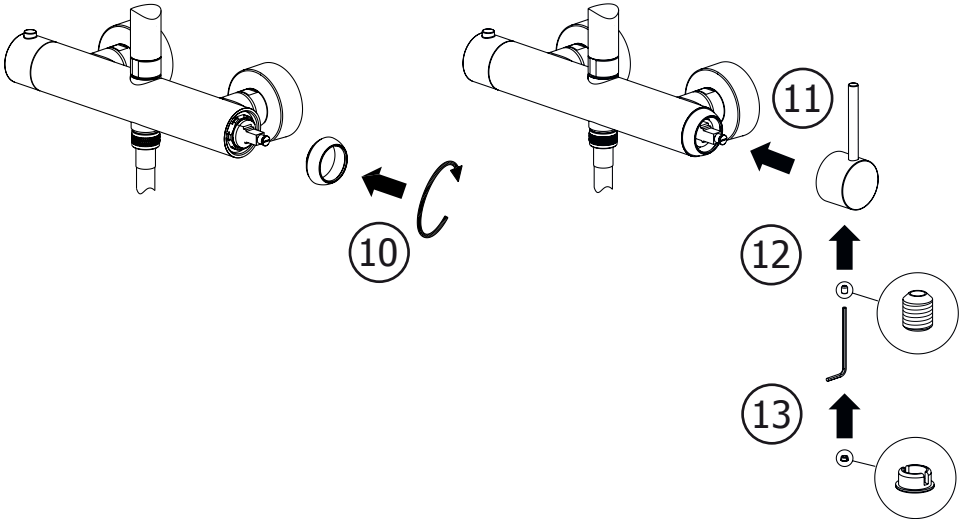
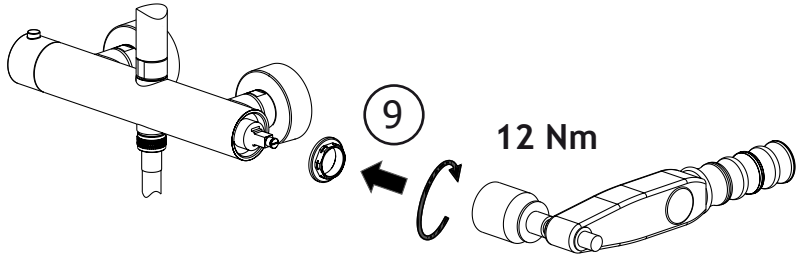
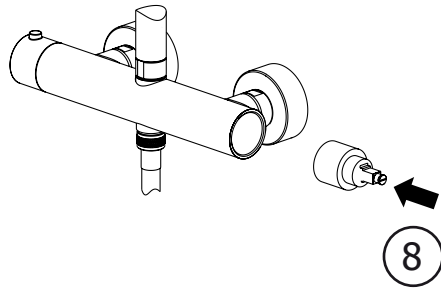

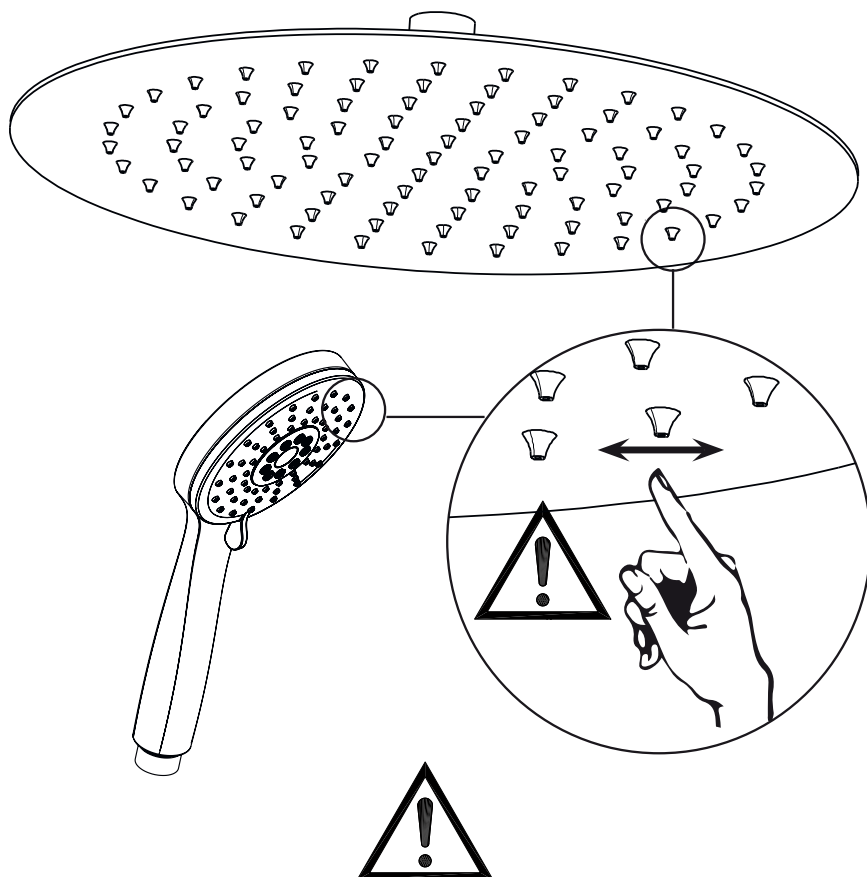

Pressione dinamica minima di utilizzo consigliata 1,5 bar
Pulire regolarmente gli ugelli

Minimum Dynamic Pressure Suggested 1,5 bar
clean the nozzles periodically

Pression dynamique minimum recommandée 1,5 bar
Nettoyer régulièrement les picots

Empfehlender min. dynamischer Nutzungsdruck 1,5 Bar
Düsen regelmäßig reinigen

Presión dinámica mínima de trabajo recomendada 1,5 bar
Limpiar regularmente las salidas de agua anti-cal

ATTENZIONE: Consegnare queste istruzioni all'utilizzatore e conservarle.

WARNING: Please leave these instructions with the user and keep them.

ATTENTION: Remettre ces instructions à l'utilisateur et les conserver.

ACHTUNG: Geben Sie bitte dem Käufer der Armatur diese Anweisungen zur Aufbewahrung.

ATENCION: Entregar estas instrucciones al usuario y conservarlas.

OPGELET: Bij de levering van kraanwerk, gelieve de gebruiksvoorwaarden en Onderhouds-methoden mee te leveren.