

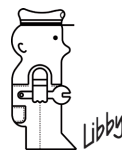

cisal.it



**cisal**  
RUBINETTERIA

1

MANIGLIA OPZIONE A - OTTONE  
HANDLE OPTION A - BRASS



MANIGLIA OPZIONE B - MARMO  
HANDLE OPTION B - MARBLE



**Fabbricato in Italia - Made in Italy**

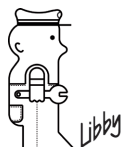

**cisal**  
RUBINETTERIA

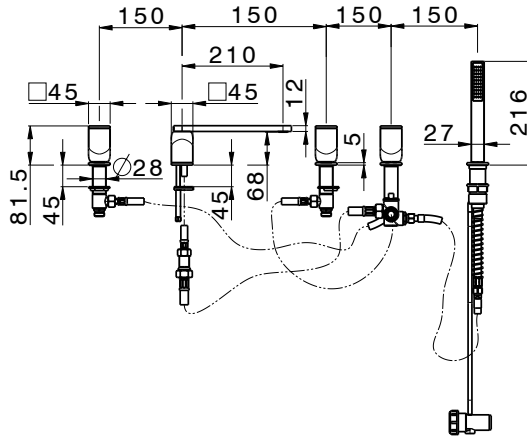
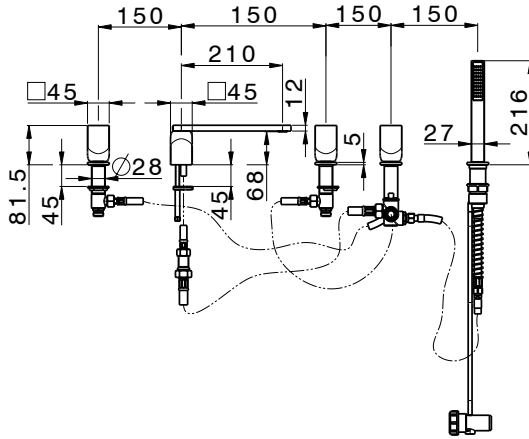

**ATTENZIONE:** Consegnare queste istruzioni all'utilizzatore e conservarle.

**WARNING:** Please leave these instructions with the user and keep them.

**ATTENTION:** Remettez ces instructions à l'utilisateur et les conservez.

**ACHTUNG:** Geben Sie bitte dem Käufer der Armatur diese Anweisungen zur Aufbewahrung.

**ATENCION:** Entregar estas instrucciones al usuario y conservarlas.

**OPGELET:** Bij de levering van kraanwerk, gelieve de gebruiksvoorwaarden en Onderhouds-methoden mee te leveren.

**I CONDIZIONI DI ESERCIZIO**

- Pressione dinamica minima.....1 bar
- Pressione di esercizio raccomandata (statica).....3 bar  
(ATTENZIONE: per pressioni superiori a 5 bar si raccomanda di installare un riduttore di pressione)
- Pressione massima di esercizio (statica).....5 bar
- Pressione massima di prova (statica).....16 bar
- Temperatura massima acqua calda.....80 °C
- Temperatura raccomandata acqua calda.....65 °C (per sicurezza e risparmio energetico)

**GB OPERATING CONDITIONS**

- Minimum dynamic pressure.....1 bar
- Recommended working pressure (static).....3 bar  
(ATTENTION: when pressure exceeds 5 bar, the installation of a pressure reducer is recommended)
- Maximum working pressure (static).....5 bar
- Maximum test pressure (static).....16 bar
- Maximum hot water temperature.....80 °C
- Recommended hot water temperature.....65 °C (for safety and energy saving)

**F CONDITIONS DE SERVICE**

- Pression dynamique minimum .....1 bar
- Pression de service recommandée (statique).....3 bar  
(En cas de pression supérieure à 5 bar il est recommandé d'installer un réducteur de pression)
- Pression de service maximum (statique).....5 bar
- Pression maximum de test (statique).....16 bar
- Température maximum eau chaude .....80 °C
- Température recommandée eau chaude.....65 °C (pour sécurité et économie d'énergie)

**D TECHNISCHE DATEN**

- Minimaler dynamischer Druck .....1 bar
- Empfohlener Betriebsdruck (statisch) .....3 bar  
(Bei mehr als 5 bar ist der Einbau eines Druckverminderers unerlässlich)
- Maximaler Betriebsdruck (statisch).....5 bar
- Maximaler Prüfdruck (statisch).....16 bar
- Maximale Warmwassertemperatur.....80 °C
- Empfohlene Warmwassertemperatur .....65 °C (zur Energieeinsparung)

**E DATOS TÉCNICOS**

- Presión dinámica mínima.....1 bar
- Presión de trabajo recomendada (estática).....3 bar  
(N.B.: para presiones superiores a los 5 bar les recomendamos instalar un reductor de presión)
- Presión máxima de trabajo (estática).....5 bar
- Presión máxima de prueba (estática).....16 bar
- Temperatura máxima agua caliente.....80 °C
- Temperatura recomendada agua caliente .....65 °C (para ahorrar energía)

**NL TECHNISCHE GEGEVENS**

- Minimum dynamische druk .....1 bar
- Aanbevolen bedrijfsdruk (statisch) .....3 bar  
(N.B: in geval van druk, hoger dan 5 bar, raden wij u aan een drukverminderingsklep te installeren)
- Maximum bedrijfsdruk (statisch).....5 bar
- Maximum proefdruk (statisch).....16 bar
- Maximum warmwatertemperatuur.....80 °C
- Aanbevolen warmwatertemperatuur .....65 °C (voor energiebesparing)

MANIGLIA OPZIONE A - OTTONE  
HANDLE OPTION A - BRASS

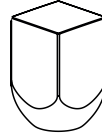

Non inclus / Not included / Non incluso / Nicht Dabei / No incluido / Nitinbegrepen

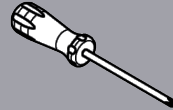
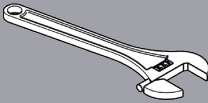

Incluso / Included / Inclus / Dabei / Incluido

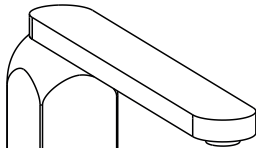

B1

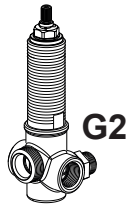

G2

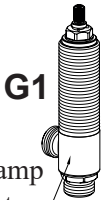

G1

Red Stamp  
Hot Water



G1

Blue Stamp  
Cold Water



G3

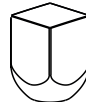

H1x(3)



H2x(3)



H3x(3)



I1x(3)



I2x(3)



L1x(3)



Mx(3)



N1



N2



N3



N4



D1



D2



D3



D4



D5



F1



P



Ex(2)



F2



F3



F4

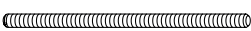

A1



A2



A3



A4



A5

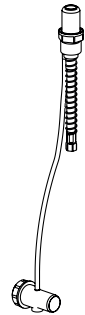

O

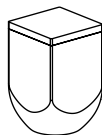

Non inclus / Not included / Non incluso / Nicht Dabei / No incluido / Nitinbegrepen

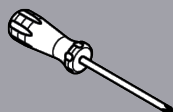
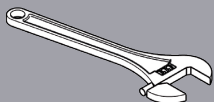

Incluso / Included / Inclus / Dabei / Includo

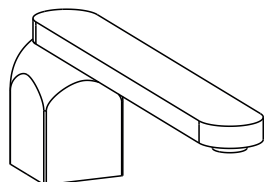

B1

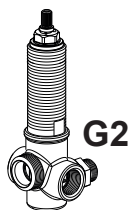

G2



G1

Red Stamp  
Hot Water

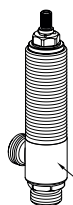

G1

Blue Stamp  
Cold Water



G3

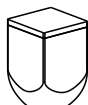

H1x(3)



H2x(3)



H3x(3)



I1x(3)



I2x(3)



L1x(3)



Mx(3)

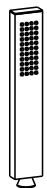

N1



N2



N3



N4

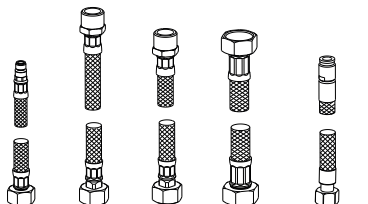

D1

D2

D3

D4

D5



F1



P



Ex(2)



F2



F3



F4

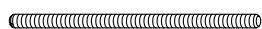

A1



A2



A3



A4



A5



O

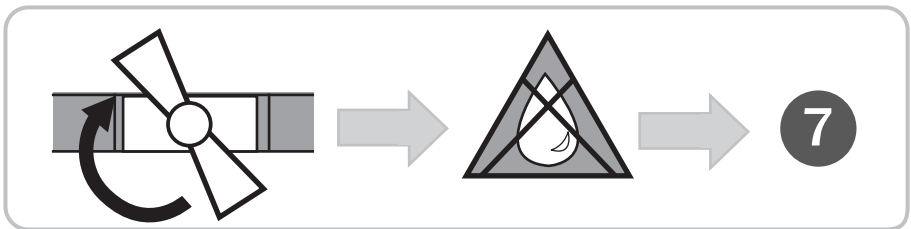
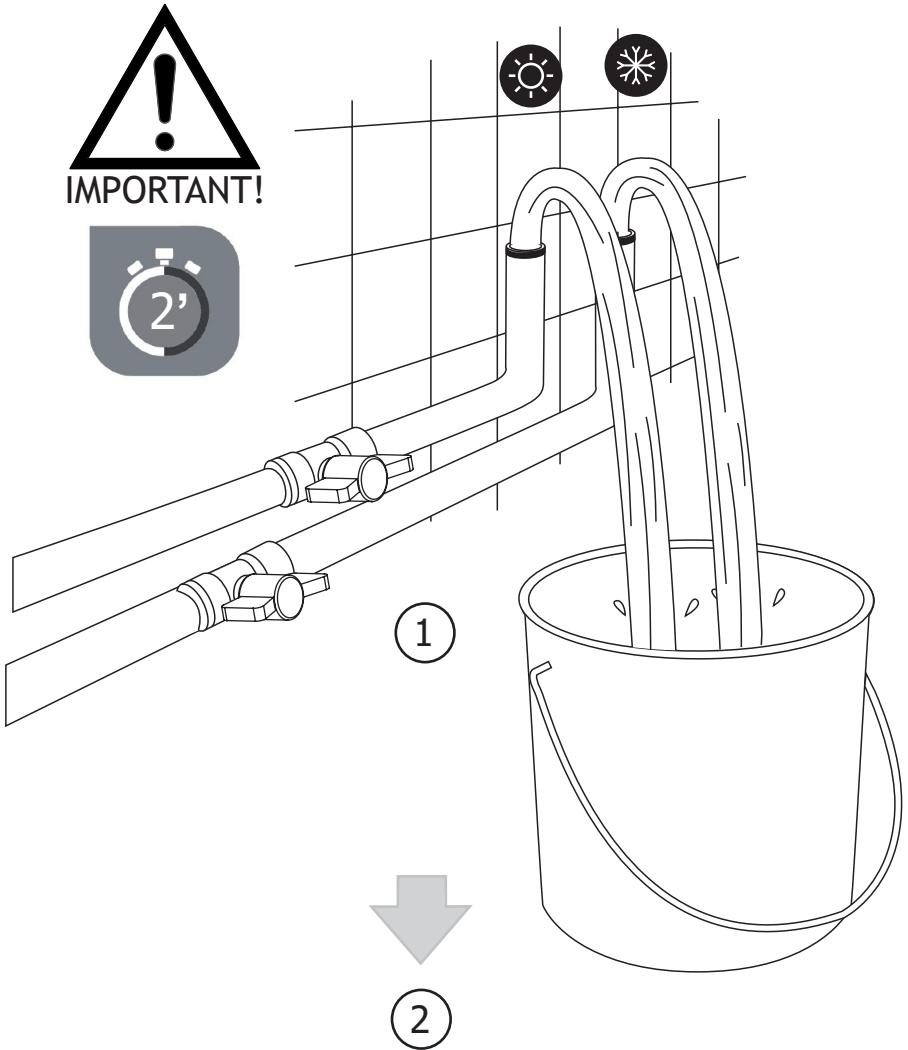

7

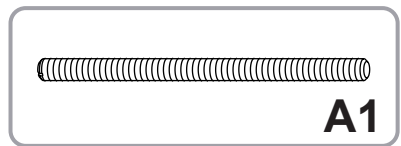
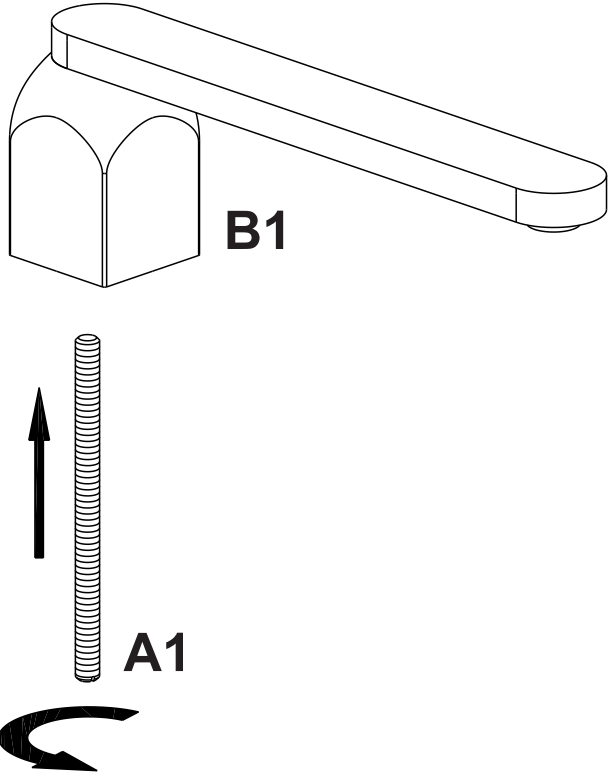
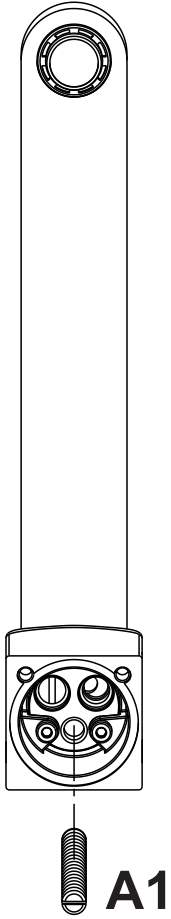



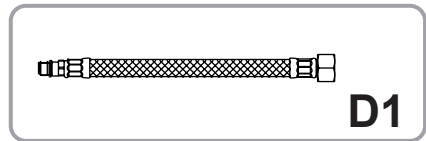
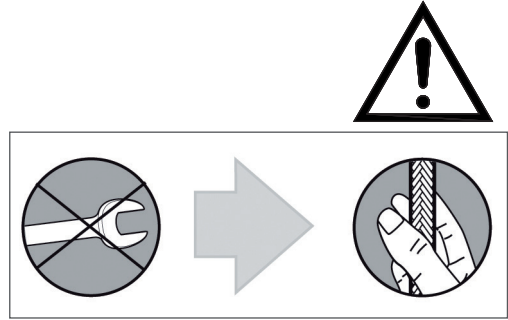
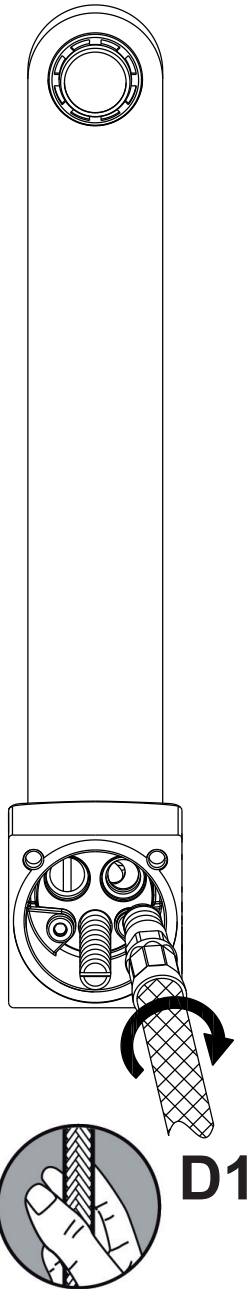

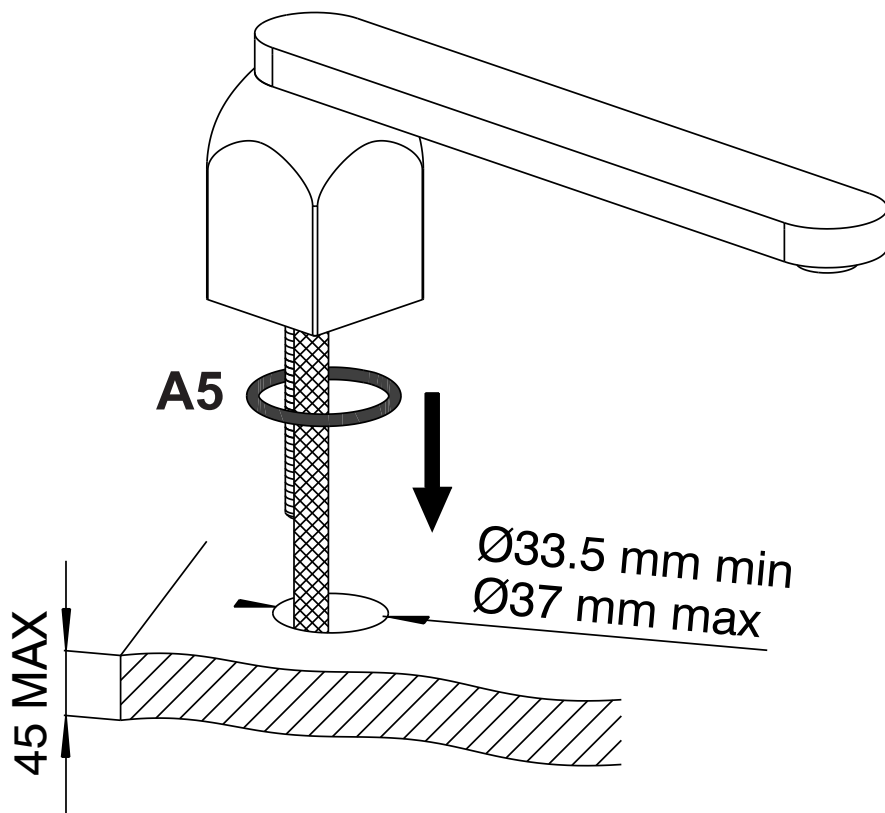

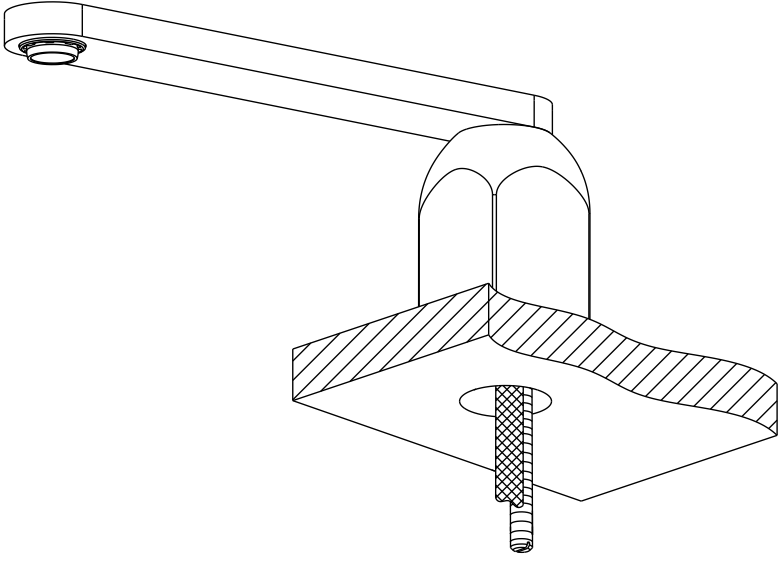





**A4**



 <b>A2</b>	 <b>A3</b>	 <b>A4</b>	
--	--	--	--

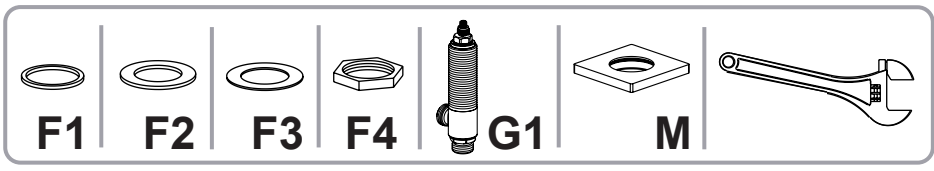
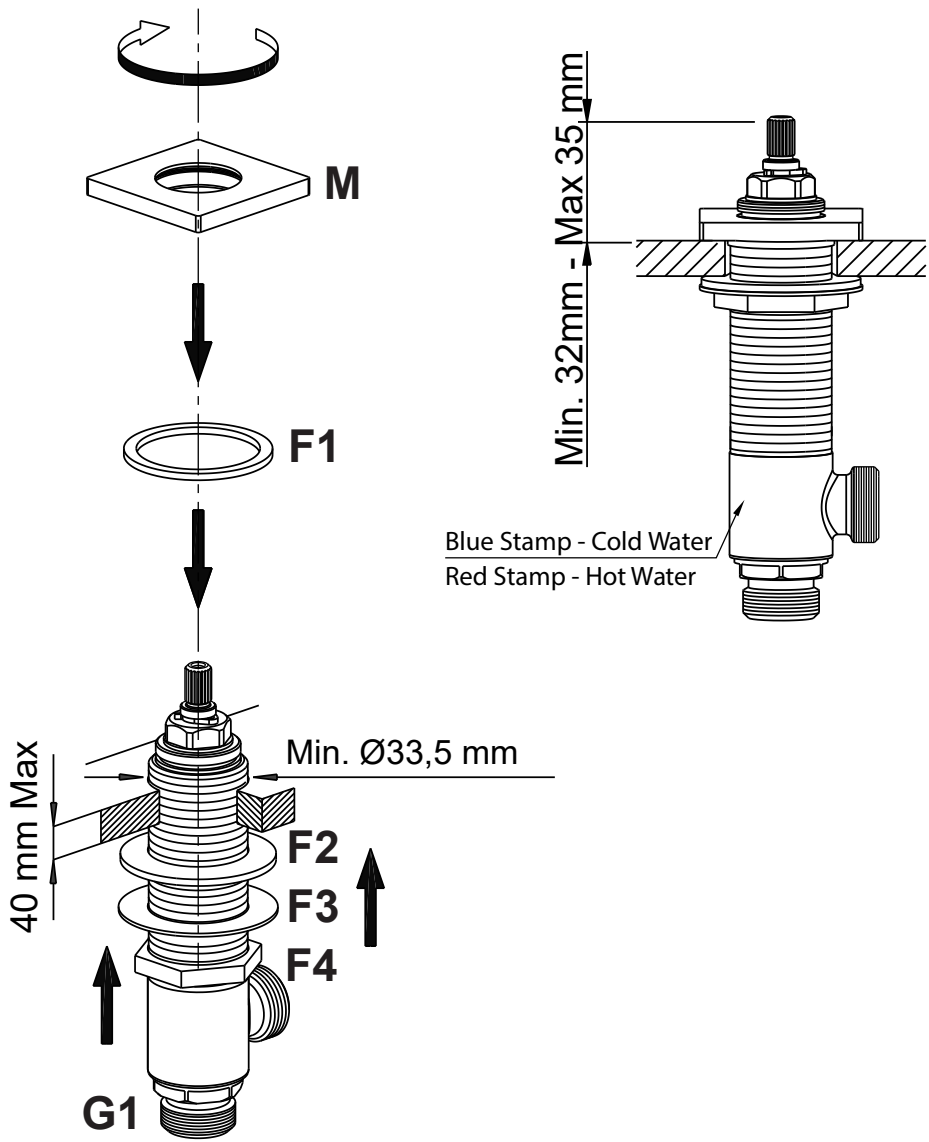

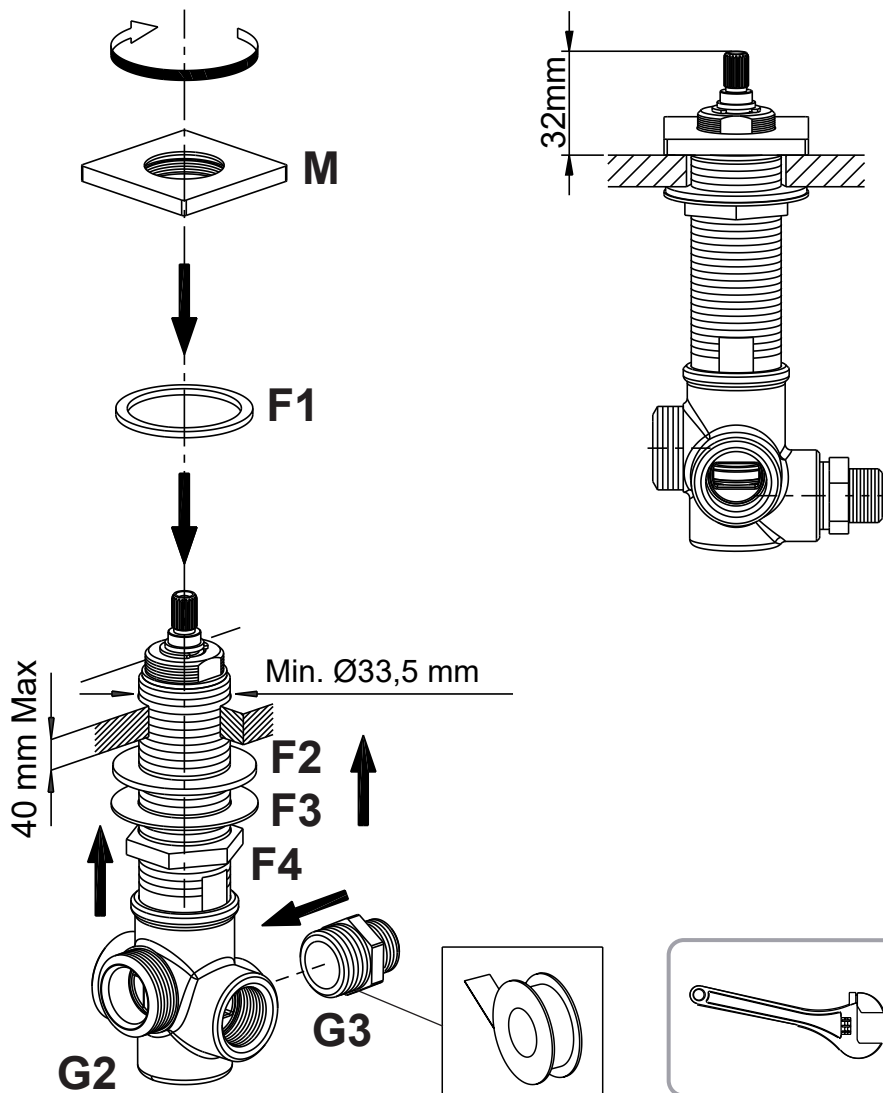

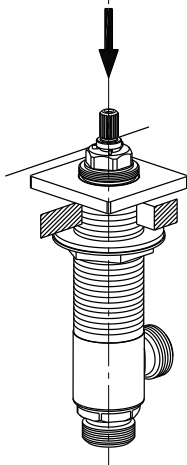
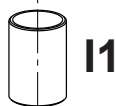
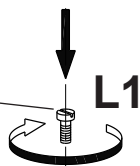
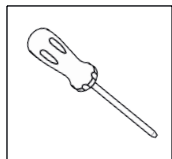
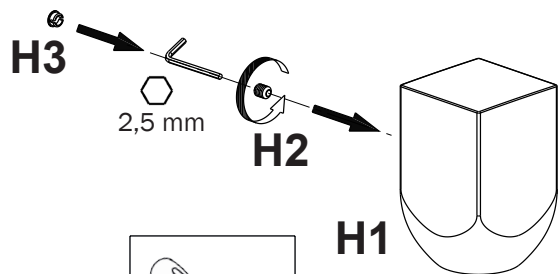

OPTION A

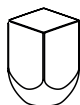
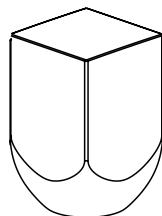

H1



H2



H3



I1



L1

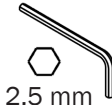

2,5 mm

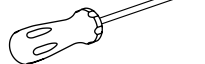

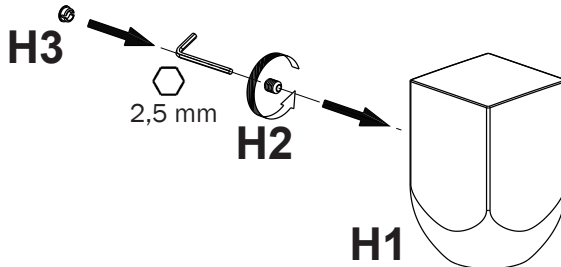

OPTION A

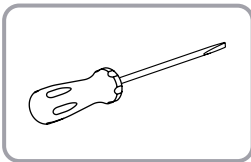
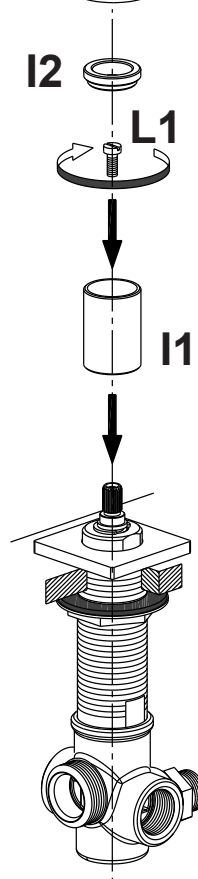
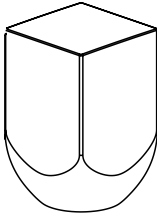

	<p><b>H1</b></p>		<p><b>H2</b></p>		<p><b>H3</b></p>		<p><b>I1</b></p>		<p><b>I2</b></p>		<p><b>L1</b></p>	<p>2,5 mm</p>
--	------------------	--	------------------	--	------------------	--	------------------	--	------------------	--	------------------	---------------

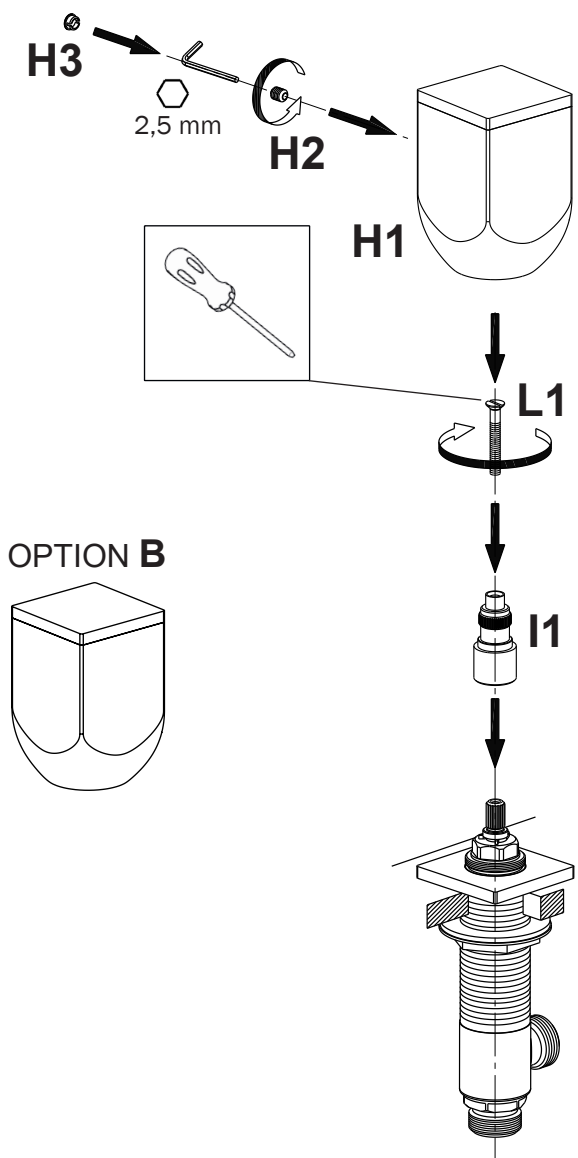

OPTION B

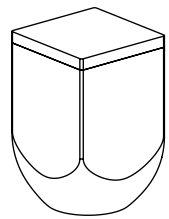

<b>H1</b>	<b>I1</b>	<b>H3</b>	<b>I1</b>	<b>L1</b>	2,5 mm	



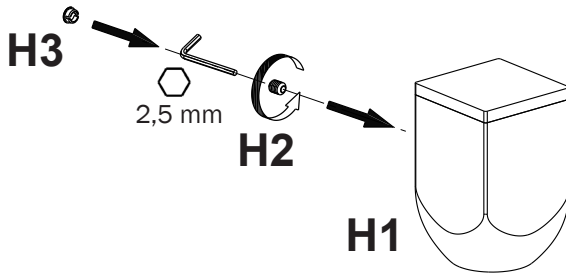

OPTION B

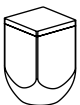
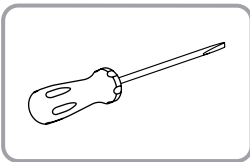
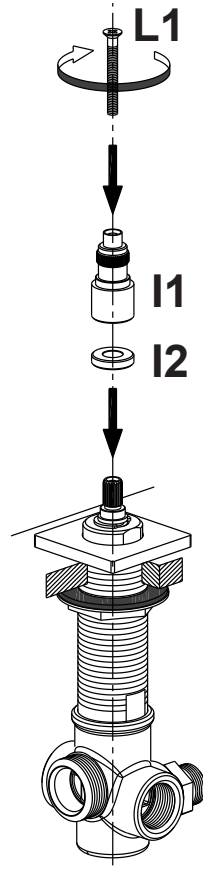
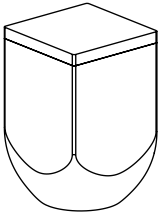

H1



H2



H3



I1



I2



L1

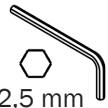

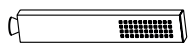
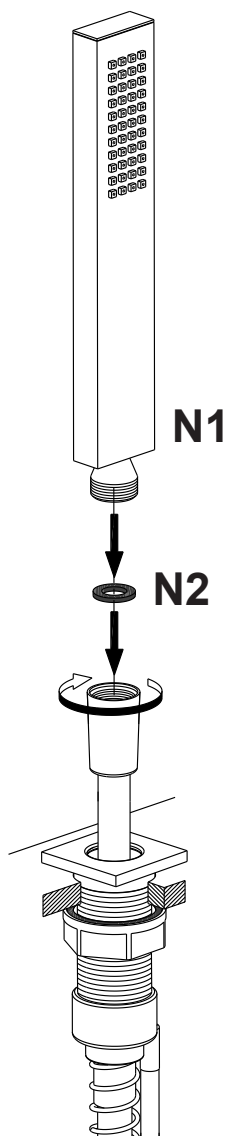
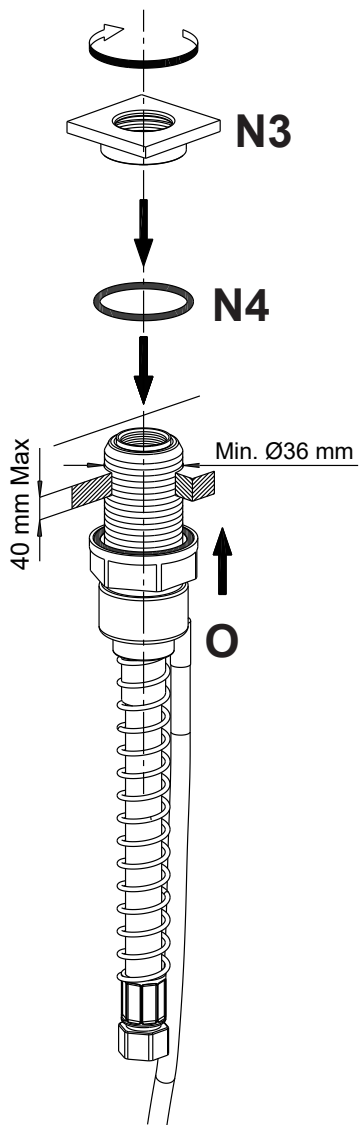

N1



N2



N3



N4



O

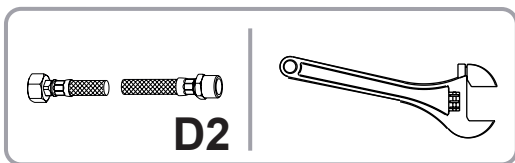
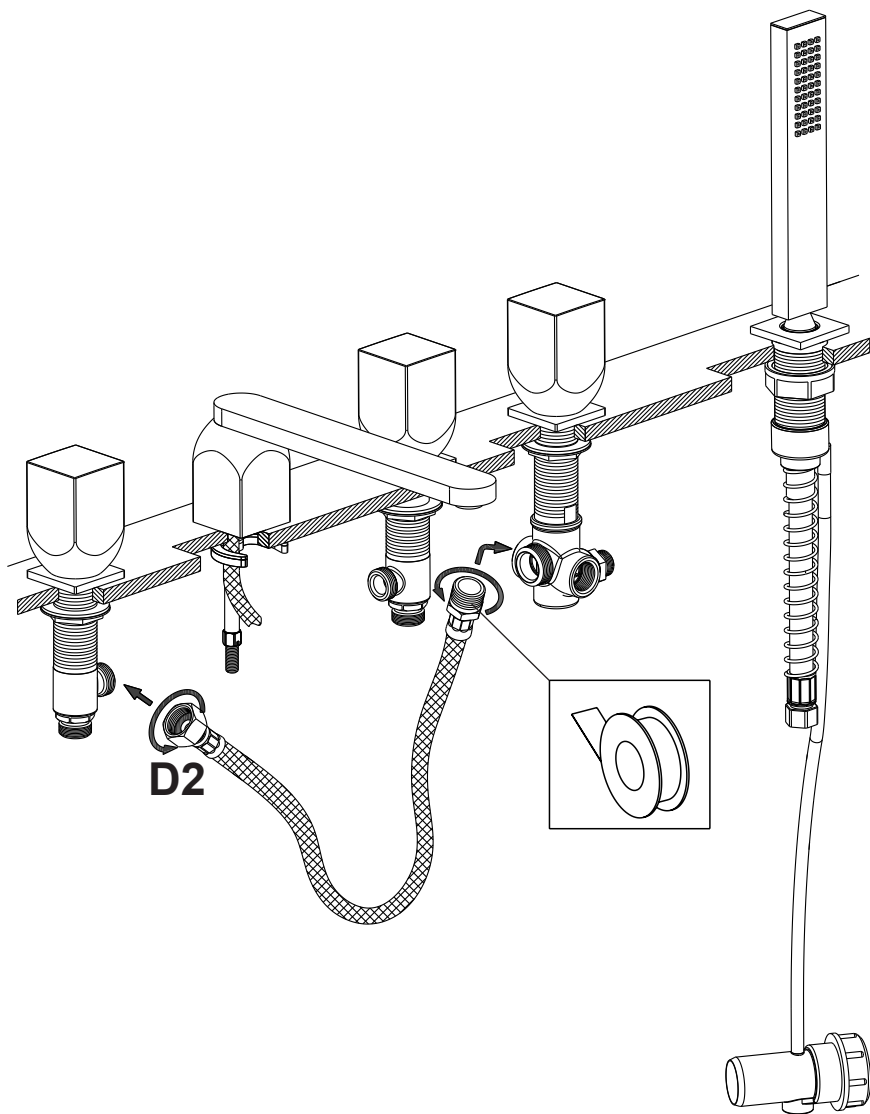

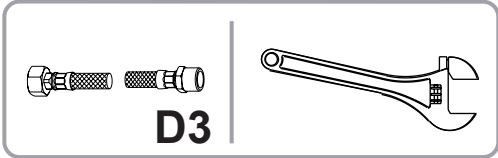
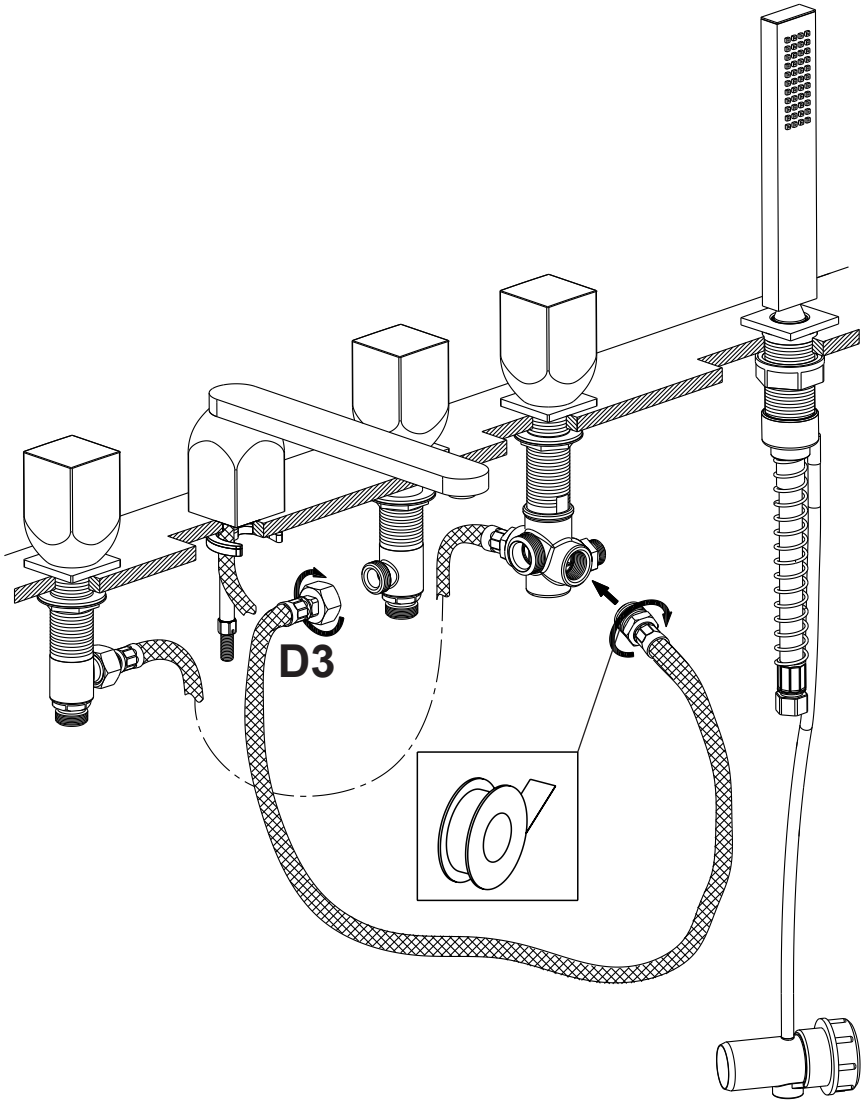

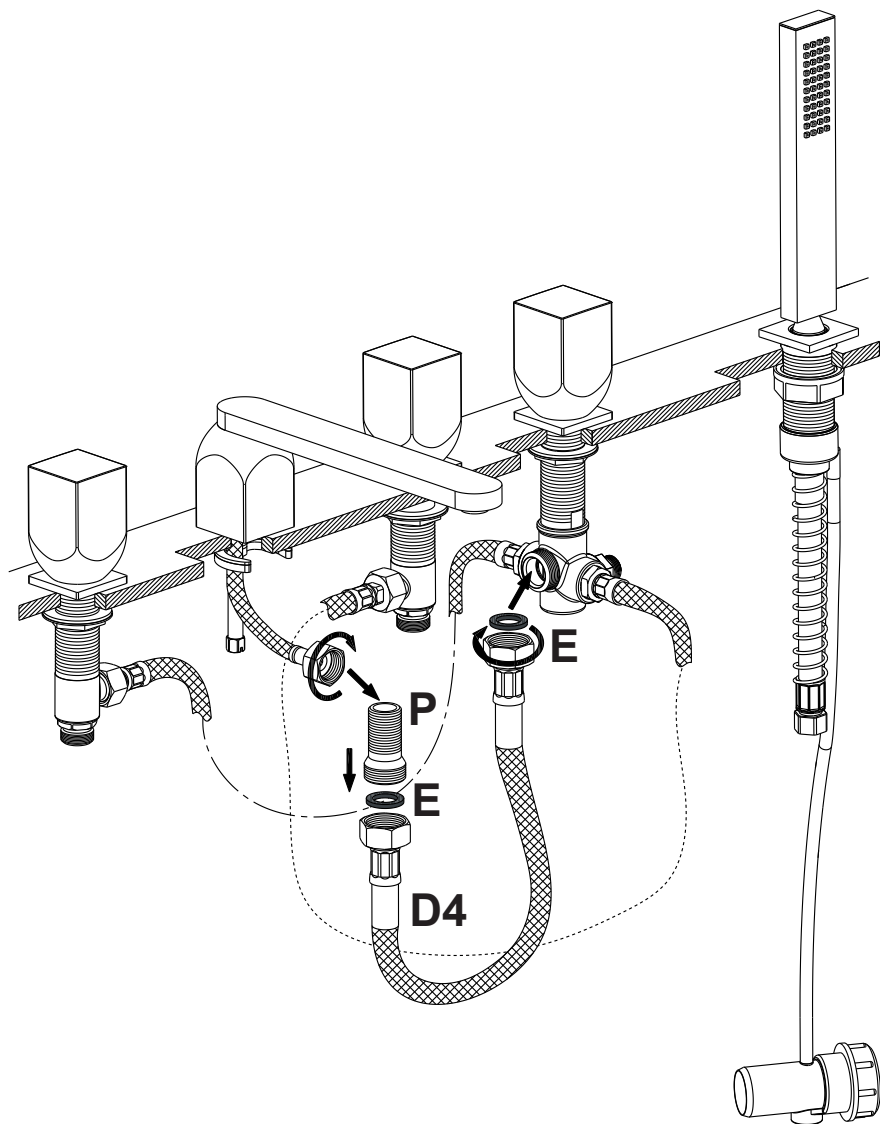
**D4****P****E<sub>x2</sub>**

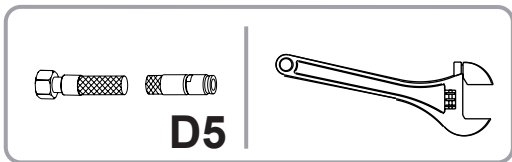
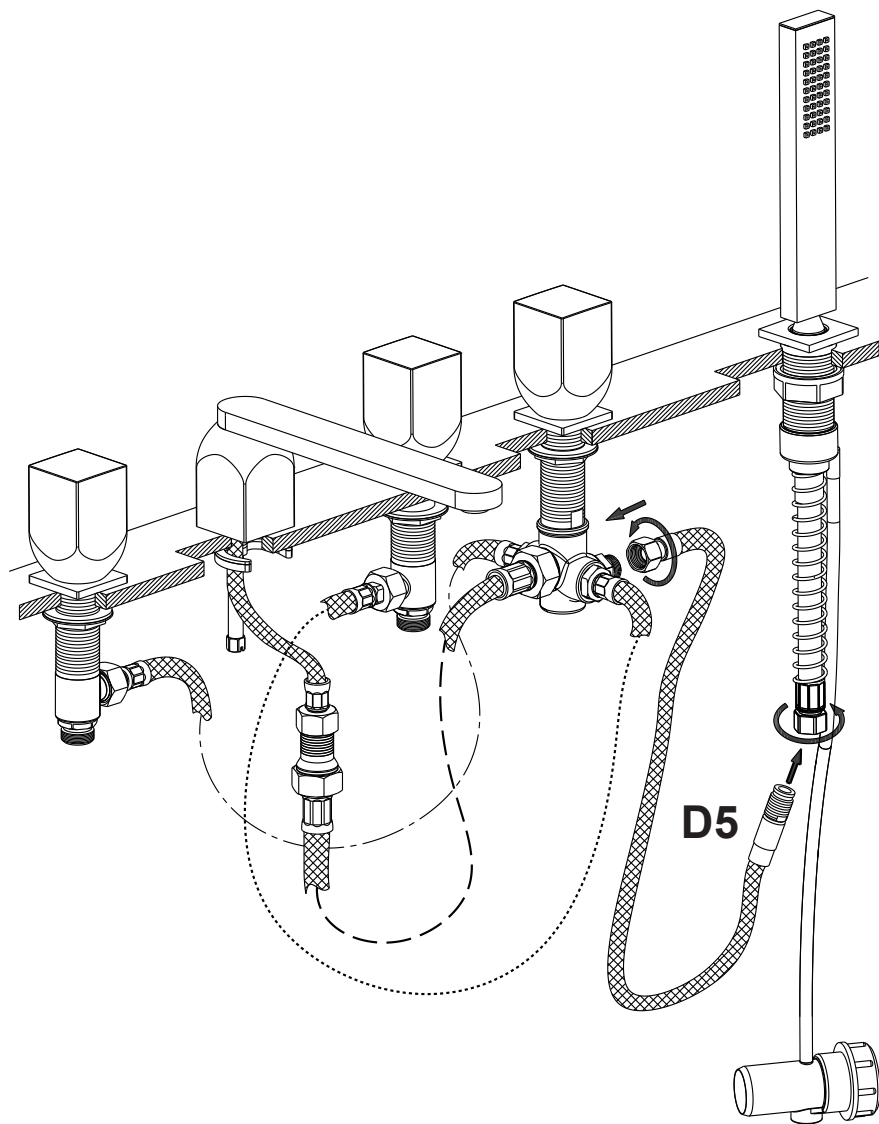

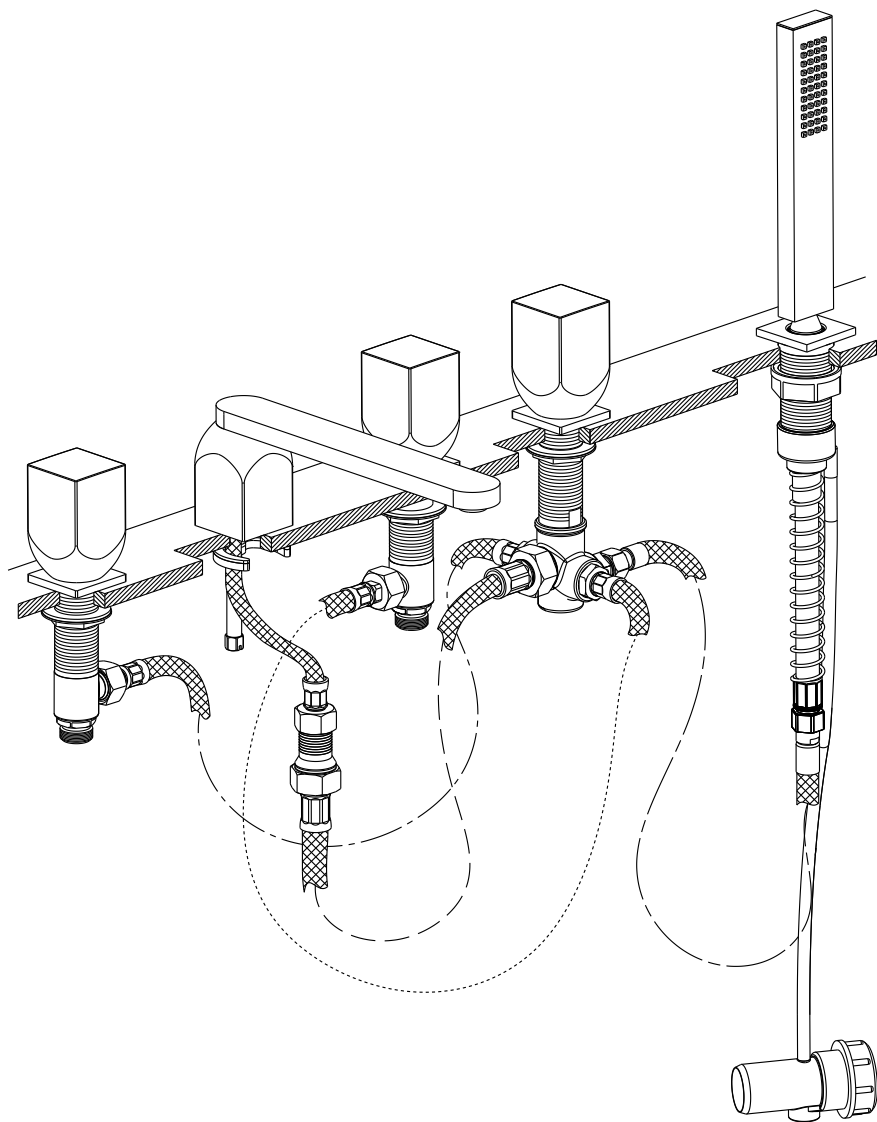

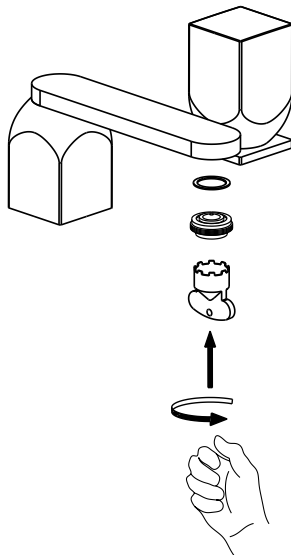
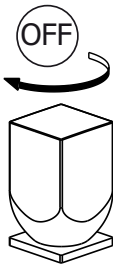
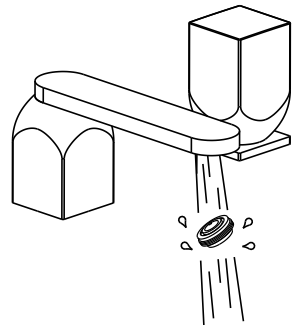
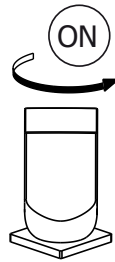
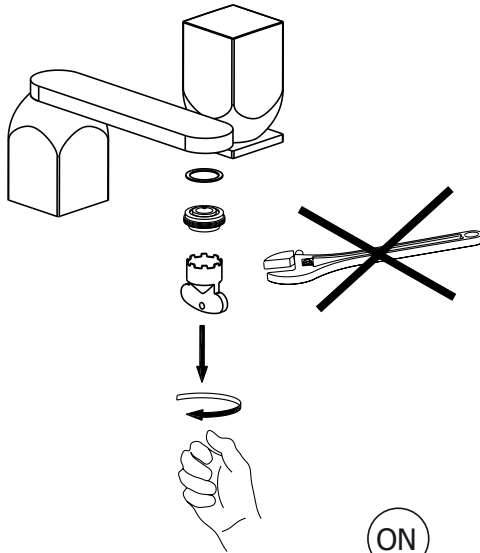
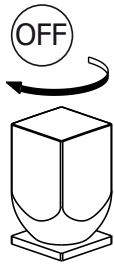

M21,5x1



Non inclus / Not included / Non incluso / Nicht Dabei / No incluido / Nitinbegrepen

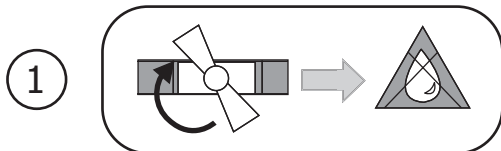
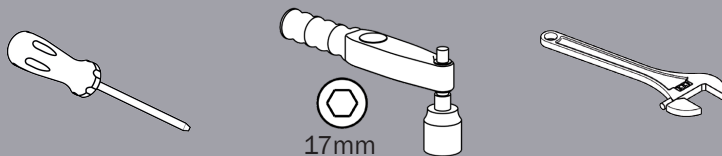

OPTION A

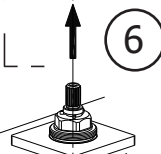
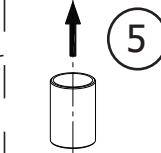
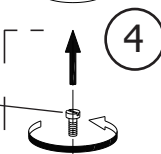
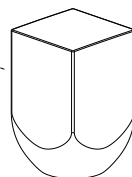
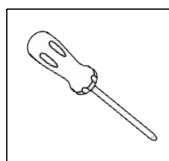
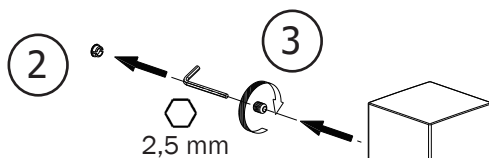
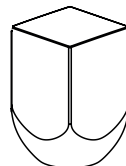

OPTION B

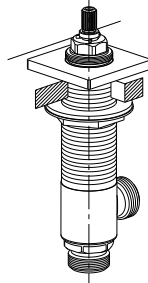
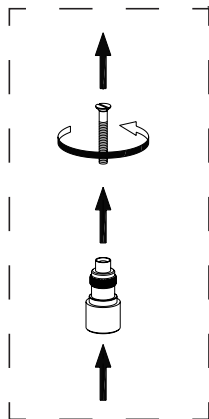
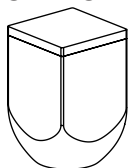

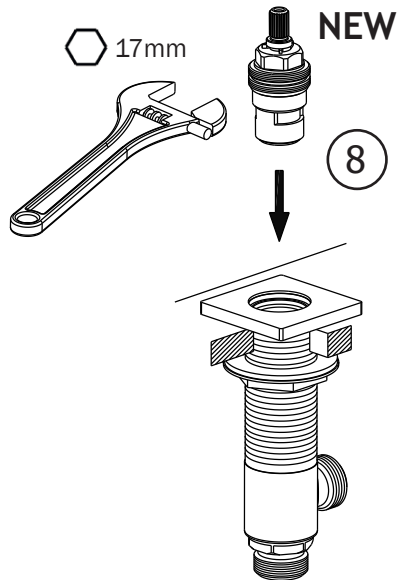
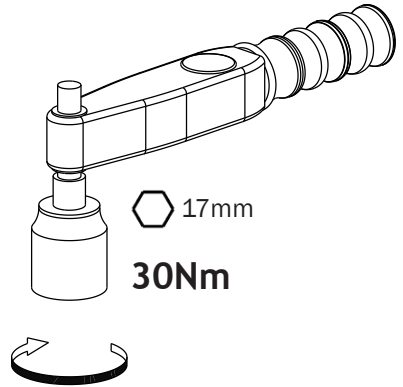
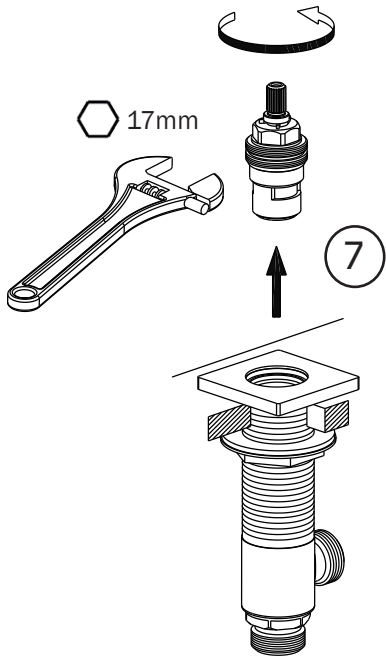

OPTION A

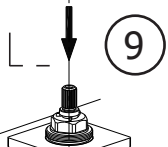
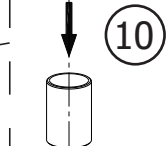
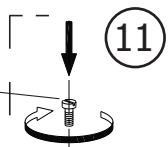
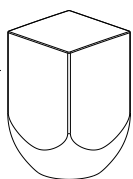
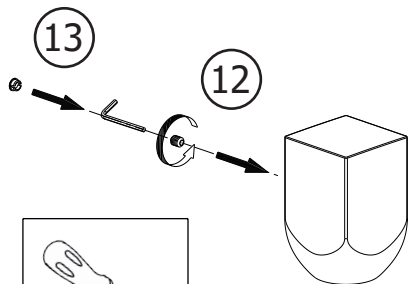
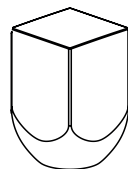

OPTION B

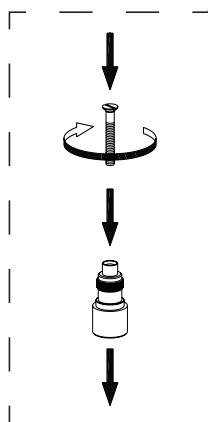
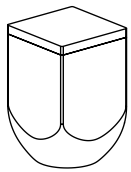

14

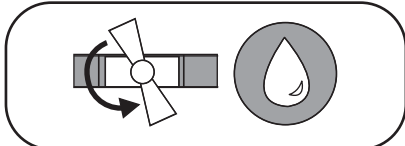

cisal.it

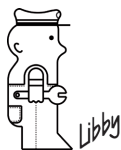

**cisal**  
RUBINETTERIA

**CISAL**

Via Pietro Durio, 160  
28010 Alzo di Pella (Novara) - Italia  
Tel. +39.0322.918111  
Fax +39.0322.969518  
cisal@cisal.it

---

**ATTENZIONE:** Consegnare queste istruzioni all'utilizzatore e conservarle.

**WARNING:** Please leave these instructions with the user and keep them.

**ATTENTION:** Remettre ces instructions à l'utilisateur et les conserver.

**ACHTUNG:** Geben Sie bitte dem Käufer der Armatur diese Anweisungen zur Aufbewahrung.

**ATENCION:** Entregar estas instrucciones al usuario y conservarlas.

**OPGELET:** Bij de levering van kraanwerk, gelieve de gebruiksvoorwaarden en Onderhouds-methoden mee te leveren.